

FITTINGS, RØR, LIM, VÆRKTØJ

Side	Afsnit 17
2	Foliegennemførsler
3	Bunddræn
4	Belufterbunddræn & belufterhætter
5 - 6	PP Fittings & rør
7- 15	PVC fittings
15-16	PVC haner
17	PVC Skydeventiler
18	PVC Motorventiler
19	Flyde & magnetventiler
20	Rustfri magnetventiler
21- 22	PVC kontraventiler & filterkurve
22	PVC Klap & butterflyventiler
23	PVC Flanger
24- 25	O-ringe, pakninger & fiberringe
26- 27	PVC gennemførsler & unioner
28- 37	PVC gevind fittings
38	Transparente rør
39	PVC rør
40	PVC gevindrør & møtrikker
40	PVC rørholdere & underlag
41	Monteringsbolte & rørholdere
42- 43	Gummi Flex / Fernco fittings
44- 45	Flex-Fil PVC fittings
46	Spa Flexslanger & SPX slanger
47	Overgangs fittings PE til PVC
48- 51	PE spændfittings
52	PE rør
53- 55	Messing spænd & gevindfittings
55	Metal haner & fittings
56	Flowmålere
57	Manometre & vandmålere
58- 59	Lim, tætning og tilbehør
60- 61	Værktøj & limpistoler
62- 63	Alu. Slangefittings & saddeknægte
63- 64	Saddeknægte / anbringbøjler

Foliegennemføring med flange

Tank- / beholder- / foliegennemføring.
Fremstillet i ABS, dobbelt indvendig limforbindelse, galvaniserede skruer.

Best. nr.	Artikel	EAN/Barcode
PG 001700	25 mm.	5704979419010
PG 001710	32 mm.	5704979419027
PG 001720	40 mm.	5704979419034
PG 001730	50 mm.	5704979419041
PG 001740	63 mm.	5704979419058
PG 001750	75 mm.	5704979419065
PG 001760	90 mm.	5704979419072
PG 001780	110 mm.	5704979419089
PG 001800	110 mm. buet	5704979419096



Gennemføring RTF - Ekstra stærk - Rustfri skruer

Tank- / foliegennemføringer fra R.T.F. er udstyret med dobbelt limmuffe og skruer i rustfrit stål.

Best. nr.	Artikel	EAN/Barcode
PG 001500	40 mm.	5704979419157
PG 001510	50 mm.	5704979419164
PG 001520	63 mm.	5704979419171
PG 001530	75 mm.	5704979419188
PG 001540	90 mm.	5704979419195
PG 001550	110 mm.	5704979419201
PG 001580	110 mm. med studs	5704979419218
PG 001920	45° vinklet 50/63 mm.	5704979419225

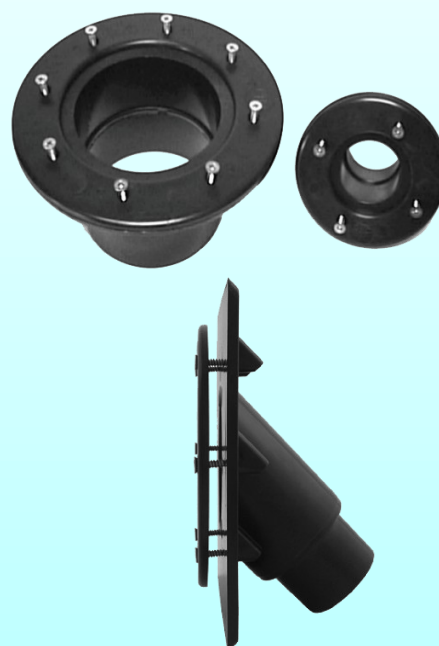

Foliegennemføring med gevind

Tank- /foliegennemføring - limforbindelse x gevind. + gummipakning

Best. nr.	Størrelse	EAN/Barcode
PG001840	32 mm.	5704979419287
PG001850	40 mm.	5704979419294
PG001860	50 mm.	5704979419300
PG001900	110 mm.	5704979419317
PG 001910	Spændeværktøj	5704979419348



Bunddræn/gennemføring

Bund-/ tankgennemføringer m. kappe, udstyret m. limmuffe

Best. nr.	Artikel	EAN/Barcode
PH 001380	50 mm.	5704979419409
PH 001400	110 mm.	5704979419416



Bunddræn/gennemføring RTF - Ekstra stærk - Lige

Bund-/ tankgennemføringer m. kappe, udstyret m. limmuffe og skruer i rustfrit stål.

Best. nr.	Artikel	EAN/Barcode
PH 001600	40 mm. RTF	5704979419478
PH 001610	50 mm. RTF	5704979419485
PH 001620	63 mm. RTF	5704979419492
PH 001630	75 mm. RTF	5704979419508
PH 001640	90 mm. RTF	5704979419515
PH 001650	110 mm. RTF	5704979419522



Bunddræn/gennemføring RTF - Ekstra stærk - Vinklet

Bund-/ tankgennemføringer m. kappe, udstyret m. limmuffe og skruer i rustfrit stål.

Best. nr.	Artikel	EAN/Barcode
PH 001700	40 mm. RTF	5704979419584
PH 001710	50 mm. RTF	5704979419591
PH 001720	63 mm. RTF	5704979419607
PH 001730	75 mm. RTF	5704979419614
PH 001740	90 mm. RTF	5704979419621
PH 001750	110 mm. RTF	5704979419638



Bunddræn med kammer

Afløb med beskyttelseskappe som forhindrer at fiskene bliver skyllet ud. Sikrer et problemfrit afløb. Med det excentriske afløb samles der mindre snavs i kamret.

Best. nr.	Artikel	EAN/Barcode
PH 001420	50 mm. med kammer	5704979419690
PH 001460	110 mm. med kammer	5704979419706



110 mm. i ekstra kraftig udførelse

**Beluftning er noget af det vigtigste for en sund hoveddam
Tilstrækkelig beluftning skaber også et sundt filter.**

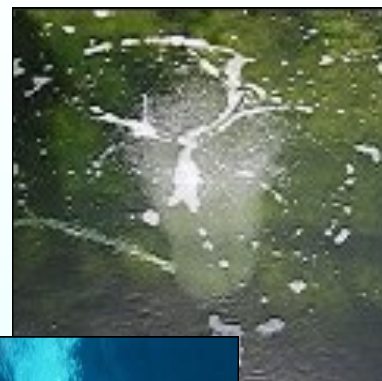

Belufterdræn med gummimembran.



Hætte til bestående bunddræn

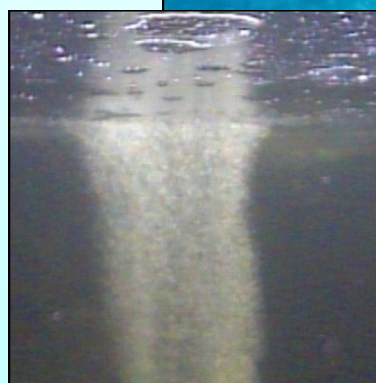

Spindrifter er det ultimative bunddræn med indbygget belufter.

Spindrifter forsynes med 60 til 120 liter luft pr. minut og vil dermed sørge for den helt optimale beluftning af enhver hoveddam.

Ved at belufte hoveddammen med tilstrækkelig ilt forøges den gavnlige bakterieflora væsentligt, til glæde og gavn for hoveddammens fisk, og for omsætningen, og dermed nedbrydningen, af skadelige stoffer.

Få en perfekt hoveddam med sunde og stærke fisk - brug en Spindrifter.

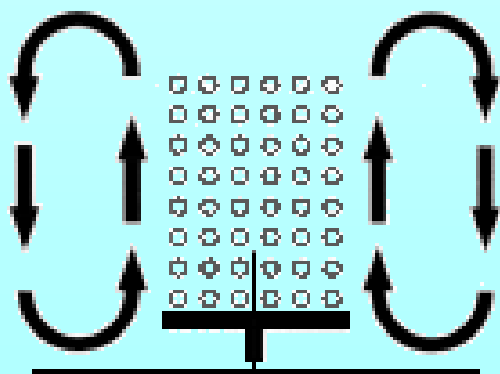

Best. nr.	Type	Luft pr. time	Farve	Rør mm	Vægt	EAN/Barcode
GZ 003252	Spindrifter dræn	3.600 til 7.200	Sort/grå	110/32 mm	5,2 kg	5704979261374
GZ 003253	Spindrifter hætte	3.600 til 7.200	Sort/grå	48,3 mm	1,8 kg	5704979261381
GZ 003254	Spindrifter hætte	3.600 til 7.200	Sort/grå	50,0 mm	1,8 kg	5704979261398

Best. nr.	Størrelse	EAN/Barcode
Samlemuffe PP - 2 x muffe Med gummipakning, sort.		
PM 001240	50 mm.	5704979422898
PM 001260	75 mm.	5704979422904
PM 001300	110 mm.	5704979422911

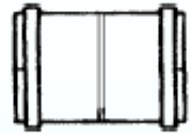

Best. nr.	Størrelse	EAN/Barcode
Glidemuffe - 2 x muffe Med gummipakning, sort.		
PM 001440	50 mm.	5704979422942
PM 001460	75 mm.	5704979422959
PM 001500	110 mm.	5704979422966

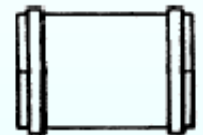

Best. nr.	Størrelse	EAN/Barcode
Vinkel 45° - 2 x muffe Med gummipakning, sort.		
PM 001640	50 mm.	5704979422997
PM 001660	75 mm.	5704979423000
PM 001700	110 mm.	5704979423017

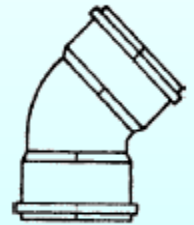

Best. nr.	Størrelse	EAN/Barcode
Vinkel 90° - 2 x muffe Med gummipakning, sort.		
PM 001840	50 mm.	5704979423048
PM 001860	75 mm.	5704979423055
PM 001900	110 mm.	5704979423062

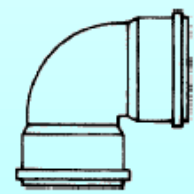

Best. nr.	Størrelse	EAN/Barcode
Vinkel 45° - 1 x split/muffe Med gummipakning, sort.		
PM 002040	50 mm.	5704979423093
PM 002060	75 mm.	5704979423109
PM 002100	110 mm.	5704979423116

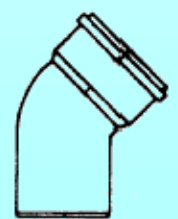

Best. nr.	Størrelse	EAN/Barcode
Vinkel 90° - 1 x split/muffe Med gummipakning, sort.		
PM 002240	50 mm.	5704979423147
PM 002260	75 mm.	5704979423154
PM 002300	110 mm.	5704979423161

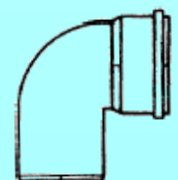

Best. nr.	Størrelse	EAN/Barcode
T-stykke 45° - 3 x muffe med gummipakning, sort.		
PM 002440	50 mm.	5704979423192
PM 002460	75 mm.	5704979423208
PM 002500	110 mm.	5704979423215

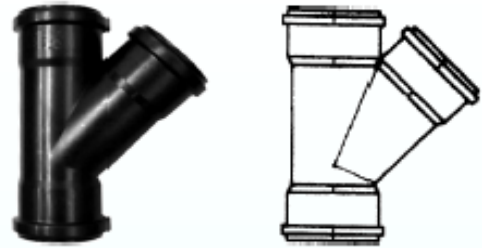

Best. nr.	Størrelse	EAN/Barcode
T-stykke 90° - 3 x muffe med gummipakning, sort.		
PM 002640	50 mm.	5704979423246
PM 002660	75 mm.	5704979423253
PM 002700	110 mm.	5704979423260

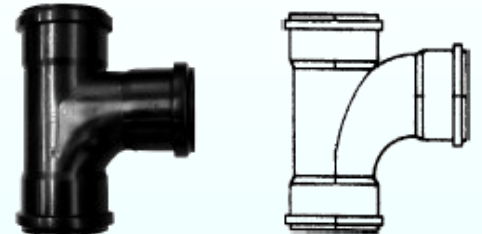

Best. nr.	Størrelse	EAN/Barcode
T-stykke 45° - 2 x muffe med gummipakning, 1 x split, sort		
PM 002840	50 mm.	5704979423291
PM 002860	75 mm.	5704979423307
PM 002900	110 mm.	5704979423314

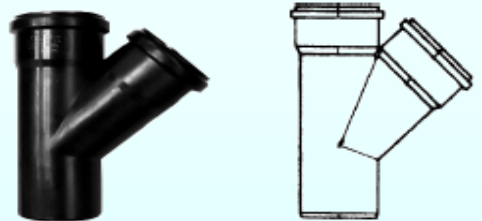

Best. nr.	Størrelse	EAN/Barcode
T-stykke 90° 2 x muffe med gummipakning, 1 x split, sort		
PM 003040	50 mm.	5704979423345
PM 003060	75 mm.	5704979423352
PM 003100	110 mm.	5704979423369

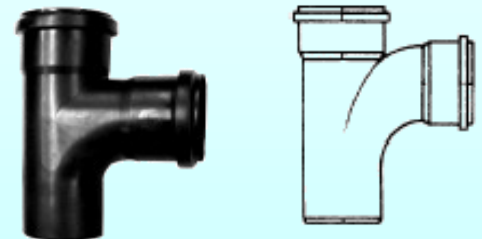

Best. nr.	Størrelse	EAN/Barcode
Reduktionsmuffe - excentrisk med gummipakning/split, sort		
PM 003200	50 x 40 mm.	5704979423383
PM 003220	75 x 40 mm.	5704979423390
PM 003240	75 x 50 mm.	5704979423406
PM 003280	110 x 40 mm.	5704979423413
PM 003300	110 x 50 mm.	5704979423420
PM 003320	110 x 75 mm.	5704979423437
PM 003340	110 x 90 mm.	5704979423444

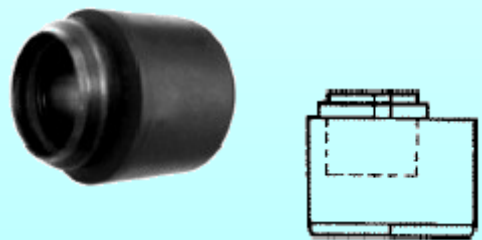

Best. nr.	Størrelse	EAN/Barcode
Slutmuffe/endekappe - sort		
PM 003420	50 mm. indskydning i muffen	5704979423475
PM 003440	75 mm. indskydning i muffen, grå	5704979423482
PM 003460	110 mm. indskydning i muffen, grå	5704979423499



Best. nr.	Størrelse	EAN/Barcode
Rør PP - glat, sort, 4 m. OBS.: Røret kan IKKE limes.		
PM 001040	50 x 44,0 mm.	5704979423529
PM 001060	75 x 69,0 mm.	5704979423536
PM 001100	110 x 103,2 mm.	5704979423543

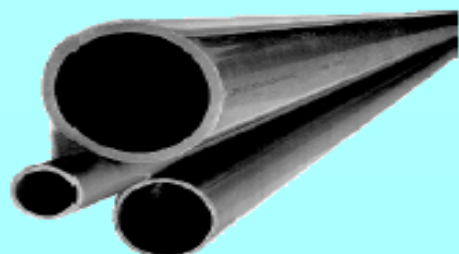

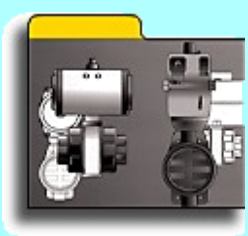
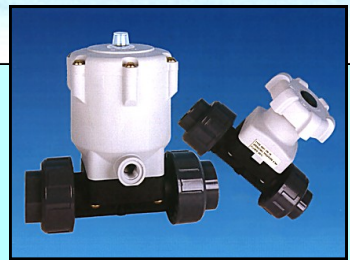

Best. Nr.	D	PN	L	Z	E	EAN/Barcode
LIMMUFFE						
PA 010098	10	16	12	3	-	5704979430985
PA 010099	12	16	12	3	18	5704979430992
PA 010100	16	16	14	3	23	5704979431005
PA 010101	20	16	16	3	26,5	5704979431012
PA 010102	25	16	19	3	33	5704979431029
PA 010103	32	16	22	3	41	5704979431036
PA 010104	40	16	26	3	50	5704979431043
PA 010105	50	16	31	3	60,5	5704979431050
PA 010106	63	16	38	3	75	5704979431067
PA 010107	75	16	44	4	88	5704979431074
PA 010108	90	16	51	5	106	5704979431081
PA 010109	110	16	61	6	129	5704979431098
PA 010110	125	16	69	7	145	5704979431104
PA 010111	140	16	76	8	161	5704979431111
PA 010112	160	16	86	8	182	5704979431128
PA 010800	32	10	22	3	41	5704979431135
PA 010801	40	10	26	3	50	5704979431142
PA 010802	50	10	31	3	60,5	5704979431159
PA 010803	63	10	38	3	75	5704979431166
PA 010804	75	10	44	4	88	5704979431173
PA 010805	90	10	51	5	106	5704979431180
PA 010806	110	10	61	6	129	5704979431197
PA 011113	200	10	106	10	227	5704979431203
PA 011114	225	10	119	11	258	5704979431210
PA 011115	250	10	131	11	272	5704979431227
PA 011116	315	10	164	12	355	5704979431234

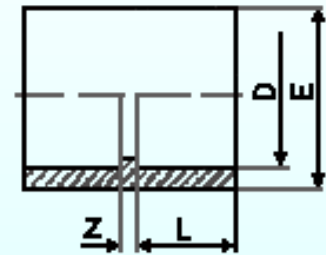

Best. nr.	d1 x d2	Z1	Z2	B	C	EAN/Barcode
Pibehoved 90° / 10 bar						
PA 031140	40 x 32	22	22	26	22	5704979431272
PA 031141	50 x 32	28	33	31	22	5704979431289
PA 031143	50 x 40	28	29	31	26	5704979431296

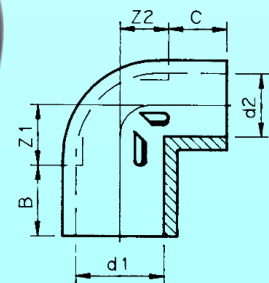

Best. nr.	d x d1	L	L1	E	H	EAN/Barcode
Reduceret vinkel 45° / 10 bar						
PA 032150	50x50/40	44	47	62	94	5704979431319
PA 032160	63x63/50	51,5	58	77	115	5704979431326

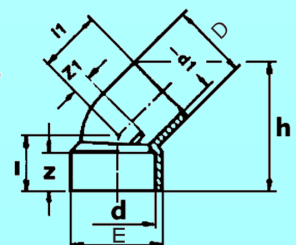

Best. Nr.	D	PN	L	Z	E	EAN/Barcode
Vinkel 90°						
PA 030118	10	16	12	6	-	5704979431333
PA 030119	12	16	12	7	18	5704979431340
PA 030120	16	16	14	9	23	5704979431357
PA 030121	20	16	16	11	26,5	5704979431364
PA 030122	25	16	19	14	33	5704979431371
PA 030123	32	16	22	17	41	5704979431388
PA 030124	40	16	26	23	50	5704979431395
PA 030125	50	16	31	28	60,5	5704979431401
PA 030126	63	16	38	34	75	5704979431418
PA 030127	75	16	44	40	89	5704979431425
PA 030128	90	16	51	48	106	5704979431432
PA 030129	110	16	61	58	129	5704979431449
PA 030130	125	16	69	66	145	5704979431456
PA 030131	140	16	76	72	164	5704979431463
PA 030132	160	16	86	81	188	5704979431470
PA 030819	25	10	19	14	33	5704979431487
PA 030820	32	10	22	17	41	5704979431494
PA 030821	40	10	26	23	50	5704979431500
PA 030822	50	10	31	28	60,5	5704979431517
PA 030823	63	10	38	34	75	5704979431524
PA 030824	75	10	44	40	89	5704979431531
PA 030825	90	10	51	48	106	5704979431548
PA 030826	110	10	61	58	129	5704979431555
PA 031133	200	10	106	102	232	5704979431562
PA 031134	225	10	119	115	258	5704979431579
PA 031135	250	10	131	188	287	5704979431586
PA 031136	315	10	164	236	359	5704979431593

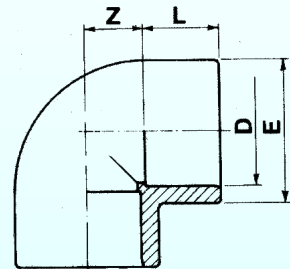

Best. Nr.	D	PN	L	Z	E	EAN/Barcode
VINKEL 45°						
PA 040138	10	16	12	3,5	-	5704979431623
PA 040139	12	16	12	3,5	18	5704979431630
PA 040140	16	16	14	5	23	5704979431647
PA 040141	20	16	16	6	26,5	5704979431654
PA 040142	25	16	19	6	33	5704979431661
PA 040143	32	16	22	8	41	5704979431678
PA 040144	40	16	26	10	50	5704979431685
PA 040145	50	16	31	12	60,5	5704979431692
PA 040146	63	16	38	15	75	5704979431708
PA 040147	75	16	44	18	89	5704979431715
PA 040148	90	16	51	21	106	5704979431722
PA 040149	110	16	61	25	128	5704979431739
PA 040150	125	16	69	27	145	5704979431746
PA 040151	140	16	76	32	164	5704979431753
PA 040152	160	16	86	36	184	5704979431760
PA 040153	200	16	106	43	232	5704979431777
PA 040829	25	10	19	6	33	5704979431784
PA 040830	32	10	22	8	41	5704979431791
PA 040831	40	10	26	10	50	5704979431807
PA 040832	50	10	31	12	60,5	5704979431814
PA 040833	63	10	38	15	75	5704979431821
PA 040834	75	10	44	18	89	5704979431838
PA 040835	90	10	51	21	106	5704979431845
PA 040836	110	10	61	25	128	5704979431852
PA 041154	225	10	119	49	258	5704979431869
PA 041155	250	10	131	58	286	5704979431876
PA 041156	315	10	164	66	359	5704979431883

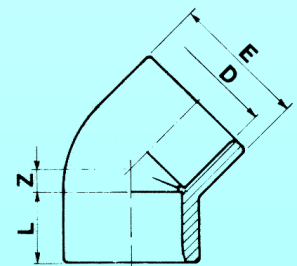

Best. Nr.	d	Z	B	T	V	EAN/Barcode
Strøm S-vinkel / 10 bar						
PA 050195	32	35	22	57	60	5704979431944
PA 050196	40	40	26	63	60	5704979431951
PA 050197	50	50	31	55	85	5704979431968

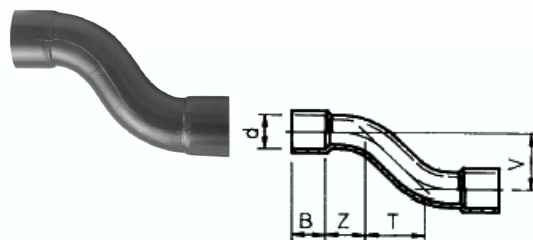

Best. nr.	d	Z	B	EAN/Barcode
Strømvinkel 90° / 10 bar * Arbejdstryk: maks. 12,5 bar				
PA 050150	32	58	22	5704979431999
PA 050151	40	72	26	5704979432002
PA 050152	50	90	31	5704979432019
PA 050153	63	95	38	5704979432026
PA 050154	75	113	44	5704979432033
PA 050155	90	135	51	5704979432040
PA 050156	*110	165	61	5704979432057
PA 050157	*125	188	69	5704979432064
PA 050158	*140	210	76	5704979432071
PA 050159	*160	240	86	5704979432088
PA 050160	*200	300	106	5704979432095
PA 050161	*250	375	131	5704979432101
PA 050162	*315	473	164	5704979432118

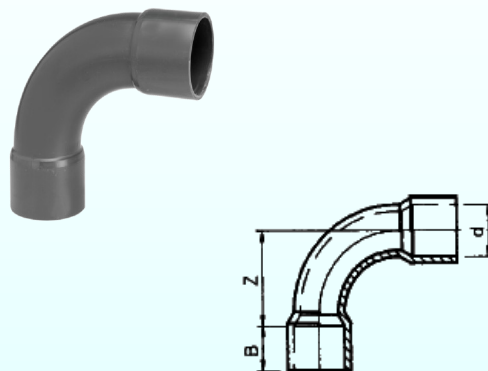

Best. nr.	d	Z	B	EAN/Barcode
Strømvinkel 45° / 10 bar * Arbejdstryk: maks. 12,5 bar				
PA 050180	32	22	22	5704979432149
PA 050181	40	27	26	5704979432156
PA 050182	50	34	31	5704979432163
PA 050183	63	36	38	5704979432170
PA 050184	75	43	44	5704979432187
PA 050185	90	51	51	5704979432194
PA 050186	*110	63	61	5704979432200
PA 050187	*125	71	69	5704979432217
PA 050188	*140	80	76	5704979432224
PA 050189	*160	92	86	5704979432231
PA 050190	*200	115	106	5704979432248
PA 050191	*250	143	131	5704979432255
PA 050192	*315	181	164	5704979432262

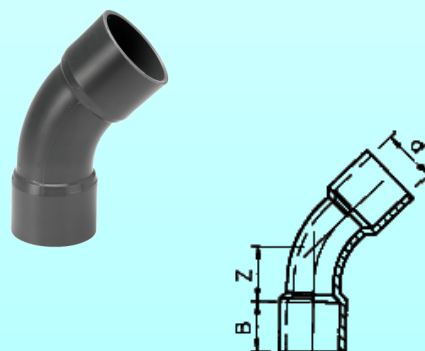

Best. nr.	d	Z	B	EAN/Barcode
Strømvinkel 30° / 12,5 bar				
PA 050170	110	79	70	5704979432293
PA 050171	125	92	79	5704979432309

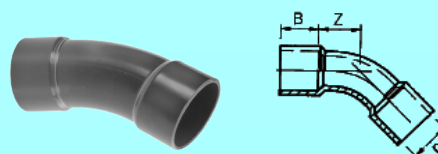

Best. Nr.	D	PN	L	Z	E	EAN/Barcode
T-stykke 90° / 10 & 16 bar						
PA 060158	10	16	12	6	-	5704979432446
PA 060159	12	16	12	7	18	5704979432453
PA 060160	16	16	14	9	23	5704979432460
PA 060161	20	16	16	11	28	5704979432477
PA 060162	25	16	19	14	34	5704979432484
PA 060163	32	16	22	17	42	5704979432491
PA 060164	40	16	26	21	51	5704979432507
PA 060165	50	16	31	26	61	5704979432514
PA 060166	63	16	38	33	75	5704979432521
PA 060167	75	16	44	39	89	5704979432538
PA 060168	90	16	51	46,5	106	5704979432545
PA 060169	110	16	61	57,5	129	5704979432552
PA 060170	125	16	69	67	148	5704979432569
PA 060171	140	16	76	71	163	5704979432576
PA 060172	160	16	86	81	190	5704979432583
PA 060839	25	10	19	14	34	5704979432590
PA 060840	32	10	22	17	42	5704979432606
PA 060841	40	10	26	21	51	5704979432613
PA 060842	50	10	31	26	61	5704979432620
PA 060843	63	10	38	33	75	5704979432637
PA 060844	75	10	44	39	89	5704979432644
PA 060845	90	10	51	46,5	106	5704979432651
PA 060846	110	10	61	57,5	129	5704979432668
PA 061173	200	10	106	102	232	5704979432675
PA 061174	225	10	119	114	258	5704979432682
PA 061175	250	10	131	128	286	5704979432699
PA 061176	315	10	164	162	360	5704979432705

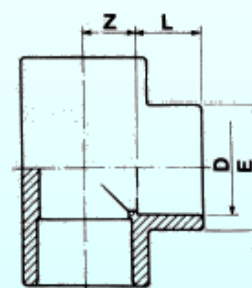

Best. nr.	d	B	Z1	Z2	EAN/Barcode
Strøm T-stykke 45° / 16 bar * = Max. Arbejdstryk 10 bar ved 20°					
PA 070309	10	12	18	4	5704979432743
PA 071295	12	12	21	4	5704979432750
PA 071296	16	14	25	5	5704979432767
PA 071297	20	16	29,5	6	5704979432774
PA 071298	25	16	35,5	7,5	5704979432781
PA 071299	32	22	44,5	9	5704979432798
PA 071300	40	26	52	10	5704979432804
PA 071301	50	31	64	12	5704979432811
PA 071302	*63	38	80	14	5704979432828
PA 071303	*75	44	95	17	5704979432835
PA 071304	*90	51	113	20	5704979432842
PA 071305	*110	61	138	24	5704979432859
PA 071307	*125	69	167	30	5704979432866
PA 072306	*160	86	201	35	5704979432873

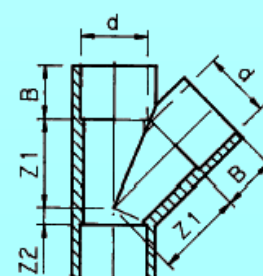
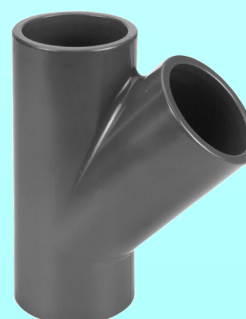

Best. Nr.	D x D	L1	L2	Z1	Z2	E1	E2	EAN/Barcode
T-stykke 90° / 16 bar - reduceret * = Max. Arbejdstryk 10 bar ved 20°								
PA 061179	20 x 12	17	13	11	12	26	17	5704979432910
PA 061180	20 x 16	16	14	11	11	27,5	23	5704979432927
PA 061181	25 x 16	19	14	14	14	33,5	24	5704979432934
PA 061182	25 x 20	19	16	14	14	32,5	28	5704979432941
PA 061183	32 x 16	22	14	17	17	42	23	5704979432958
PA 061184	32 x 20	22	16	17	17	42	28	5704979432965
PA 061185	32 x 25	22	19	17	17	42	34	5704979432972
PA 061187	40 x 20	26	16	21	21	51	28	5704979432989
PA 061188	40 x 25	26	19	21	21	51	34	5704979432996
PA 064860	*40 x 32	26	22	21	21	51	42	5704979433009
PA 061189	40 x 32	26	22	21	21	51	42	5704979433016
PA 061190	50 x 20	31	16	26	26	61	28	5704979433023
PA 061191	50 x 25	31	19	26	26	61	34	5704979433030
PA 061192	50 x 32	31	22	26	26	61	42	5704979433047
PA 061193	50 x 40	31	26	26	26	61	51	5704979433054
PA 061195	63 x 25	38	19	33	33	75	34	5704979433061
PA 061196	63 x 32	38	22	33	33	75	42	5704979433078
PA 061197	63 x 40	38	26	33	33	75	51	5704979433085
PA 061198	63 x 50	38	31	33	33	75	61	5704979433092
PA 061200	75 x 40	44	26	39	39	89	51	5704979433108
PA 061201	75 x 50	44	31	39	39	89	61	5704979433115
PA 061202	75 x 63	44	38	39	39	89	75	5704979433122
PA 061203	90 x 40	51	26	46,5	47	106	51	5704979433139
PA 061204	90 x 50	51	31	46,5	47	106	61	5704979433146
PA 061205	90 x 63	51	38	46,5	47	106	75	5704979433153
PA 061206	90 x 75	51	44	46,5	47	106	89	5704979433160
PA 061207	110 x 50	61	31	56,5	57	129	61	5704979433177
PA 061208	110 x 63	61	38	56,5	57	129	75	5704979433184
PA 061209	110 x 75	61	44	56,5	57	129	89	5704979433191
PA 061210	110 x 90	61	51	56,5	57	129	106	5704979433207
PA 061211	125 x 63	69	38	67	67	145,5	75	5704979433214
PA 061212	125 x 75	69	44	67	67	145,5	89	5704979433221
PA 061213	125 x 90	69	51	67	67	145,5	106	5704979433238
PA 061214	125 x 110	69	61	67	67	145,5	129	5704979433245
PA 062221	160 x 90	86	51	56,5	81	188	106	5704979433252
PA 063219	160 x 110	86	61	56,5	81	188	129	5704979433269
PA 063220	160 x 125	86	69	82	82	184	148	5704979433276
PA 063222	160 x 140	86	76	82	82	184	163	5704979433283

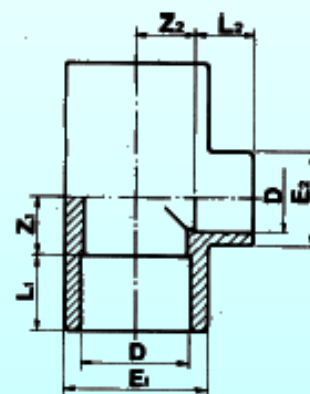

Best. Nr.	d1	B	Z	EAN/Barcode
X-stykke 90° / 16 bar * = Max. Arbejdstryk 10 bar ved 20°				
PA 080316	10	12	6,5	5704979433320
PA 080317	12	12	7,5	5704979433337
PA 080318	16	14	9,5	5704979433344
PA 080319	20	16	11	5704979433351
PA 080320	25	19	13,5	5704979433368
PA 080321	32	22	17	5704979433375
PA 080322	40	26	21	5704979433382
PA 080323	50	31	26	5704979433399
PA 080324	*63	38	22	5704979433405
PA 080325	*75	44	38	5704979433412
PA 080326	*90	51	46	5704979433429
PA 080327	*110	61	56	5704979433436

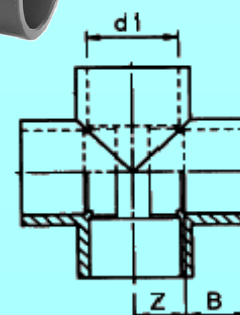

Best. nr.	D x D	L1	L2	Z	Type	EAN/Barcode
Reduktionsmuffe 16 bar						
PA 110349	16 x 12	14	12	2	A	5704979433474
PA 111347	20 x 10	16	12	4	A	5704979433481
PA 111348	20 x 12	16	12	4	A	5704979433498
PA 111350	20 x 16	16	14	2	A	5704979433504
PA 112346	25 x 12	19	12	7	B	5704979433511
PA 112351	25 x 16	19	14	5	B	5704979433528
PA 112352	25 x 20	19	16	3	A	5704979433535
PA 112353	32 x 16	22	14	8	B	5704979433542
PA 112354	32 x 20	22	16	6	B	5704979433559
PA 112355	32 x 25	22	19	3	A	5704979433566
PA 112356	40 x 20	26	16	10	B	5704979433573
PA 112357	40 x 25	26	19	7	B	5704979433580
PA 112358	40 x 32	26	22	4	A	5704979433597
PA 112359	50 x 25	31	19	12	B	5704979433603
PA 112360	50 x 32	31	22	9	B	5704979433610
PA 112361	50 x 40	31	26	5	A	5704979433627
PA 112362	63 x 32	38	22	16	B	5704979433634
PA 112363	63 x 40	38	26	12	B	5704979433641
PA 112364	63 x 50	38	31	7	A	5704979433658
PA 112365	75 x 40	44	26	18	B	5704979433665
PA 112366	75 x 50	44	31	13	B	5704979433672
PA 112367	75 x 63	44	38	6	A	5704979433689
PA 112368	90 x 50	51	31	20	B	5704979433696
PA 112369	90 x 63	51	38	13	B	5704979433702
PA 112370	90 x 75	51	44	7	A	5704979433719
PA 112371	110 x 63	61	38	23	B	5704979433726
PA 112372	110 x 75	61	44	17	B	5704979433733
PA 112373	110 x 90	61	51	10	A	5704979433740
PA 112374	125 x 75	69	44	25	B	5704979433757
PA 112375	125 x 90	69	51	18	B	5704979433764
PA 112376	125 x 110	69	61	8	A	5704979433771
PA 112377	140 x 90	76	51	25	B	5704979433788
PA 112378	140 x 110	76	61	15	B	5704979433795
PA 112379	140 x 125	76	69	7	A	5704979433801
PA 112384	160 x 90	86	61	25	B	5704979433818
PA 113380	160 x 110	86	61	25	B	5704979433825
PA 113381	160 x 125	86	69	17	B	5704979433832
PA 113382	160 x 140	86	76	10	A	5704979433849
PA 113383	200 x 160	96	86	10	A	5704979433856
PA 113387	250 x 160	132	87	45	B	5704979433863
PA 113388	250 x 200	132	97	35	A	5704979433870

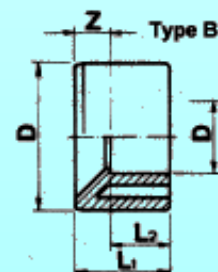
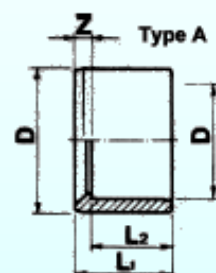

Best. Nr.	d1/D x d2	L	L1	L2	Z	E	EAN/Barcode
REDUKTIONSMUFFE / 16 bar							
PA 020468	12/16 x 10	12	12	14	6	-	5704979433917
PA 020469	16/20 x 10	14	12	16	6	-	5704979433924
PA 020471	20/25 x 12	16	12	19	9	-	5704979433931
PA 020470	20/25 x 16	16	14	19	6	23	5704979433948
PA 020472	25/32 x 16	19	14	22	6	23	5704979433955
PA 020473	25/32 x 20	19	16	22	6	28	5704979433962
PA 020476	32/40 x 20	22	16	26	6	28	5704979433979
PA 020477	32/40 x 25	22	19	26	6	33	5704979433986
PA 020480	40/50 x 25	26	19	31	10	33	5704979433993
PA 020481	40/50 x 32	26	22	31	10	41	5704979434006
PA 020485	50/63 x 32	31	22	38	12	41	5704979434013
PA 020486	50/63 x 40	31	26	38	12	50	5704979434020
PA 020490	63/75 x 40	38	26	44	17,2	50	5704979434037
PA 020491	63/75 x 50	38	31	44	12,3	61	5704979434044
PA 020495	75/90 x 50	44	31	51	17,5	61	5704979434051
PA 020496	75/90 x 63	44	38	51	11,1	75	5704979434068
PA 020499	90/110 x 50	51	31	61	28	61	5704979434075
PA 020500	90/110 x 63	50	38	61	21,5	75	5704979434082
PA 020501	90/110 x 75	51	44	61	15,7	88	5704979434099
PA 020504	110/125 x 63	61	38	69	27,5	75	5704979434105
PA 020505	110/125 x 75	61	44	69	22,8	88	5704979434112
PA 020506	110/125 x 90	61	51	69	17	106	5704979434129
PA 020510	125/140 x 90	69	51	76	24,8	106	5704979434136
PA 020511	125/140 x 110	69	61	76	16,8	129	5704979434143
PA 020516	140/160 x 110	76	61	86	18	129	5704979434150
PA 020517	140/160 x 125	76	69	86	8	145	5704979434167
PA 021293	160 x 140	-	-	-	-	-	5704979434174
PA 021294	200 x 160	-	-	-	-	-	5704979434181

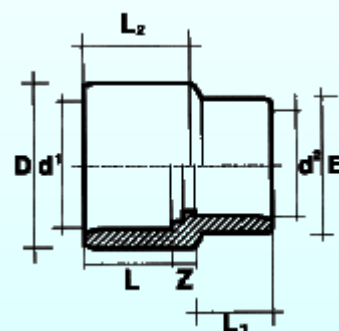
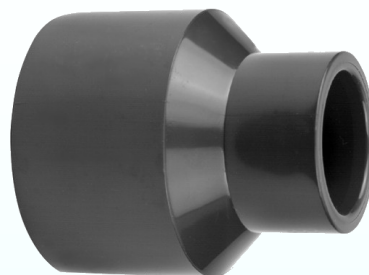

Best. Nr.	D x D	EAN/Barcode
INDSATSMUFFE metrisk - imperial (mm. - inch.) lim/lim		
PA 023090	50 mm. lim indiv. x 1-1/2" lim (48,3 mm.) udv.	5704979434211

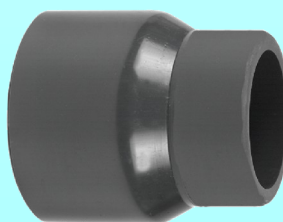

Best. Nr.	D x D	EAN/Barcode
REDUKTIONSMUFFE metrisk-imp. (mm. - inch.) lim/lim		
PA 023084	40 mm. lim x 1-1/4" lim (42 mm.)	5704979434242
PA 023085	50 mm. lim x 1-1/2" lim (48,3 mm.)	5704979434259
PA 023086	63 mm. lim x 2" lim (60,3 mm.)	5704979434266

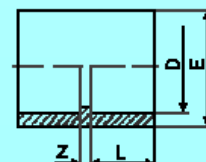

Best. nr.	D	L	H	E	EAN/Barcode
Endemuffe / 16 bar - lim * = Max. Arbejdstryk 10 bar ved 20°					
PA 120228	10	12	-	-	5704979434303
PA 120229	12	12	-	-	5704979434310
PA 120230	16	14	26	23,0	5704979434327
PA 120231	20	16	30	26,5	5704979434334
PA 120232	25	19	34	33,0	5704979434341
PA 120233	32	22	38	42,0	5704979434358
PA 120234	40	26	43	50,0	5704979434365
PA 120235	50	31	48	60,5	5704979434372
PA 120236	63	38	56	75,0	5704979434389
PA 120237	75	44	67	89,0	5704979434396
PA 120238	90	51	78	105,5	5704979434402
PA 120239	110	61	81	128,0	5704979434419
PA 120240	125	69	98	145,0	5704979434426
PA 120241	140	76	108	162,0	5704979434433
PA 120242	160	86	123	181,4	5704979434440
PA 120243	*200	106	145	227,0	5704979434457

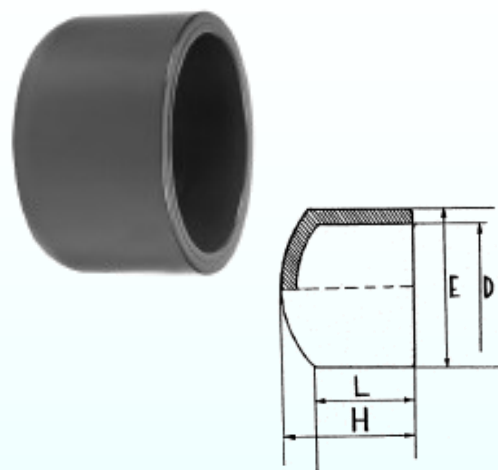

Best. Nr.	D	L	H	D1	D2	EAN/Barcode
Lim-/slangemuffe 16 bar						
PA 100459	10	12	36	10	12	5704979434488
PA 100460	12	12	48	12	14	5704979434495
PA 100461	16	14	60	16	18	5704979434501
PA 100462	20	16	67	20	22	5704979434518
PA 100463	25	19	74	25	27	5704979434525
PA 100464	32	22	80	32	34	5704979434532
PA 100465	40	26	92	40	42	5704979434549
PA 100466	50	31	101	50	52	5704979434556
PA 100467	63	38	111	60	64	5704979434563

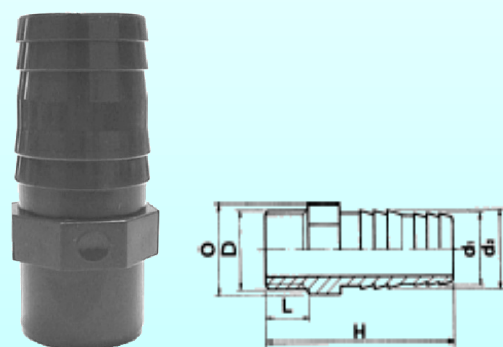

- O-ring: EPDM 70 SH, kugleindsats: PTFE (Teflon).
- Arbejdstryk 16/63 mm. 16 bar v/20° C.
- Arbejdstryk 75/110 mm. 10 bar v/20° C.
- Farve håndtag: blå (orangefarvede håndtag kan leveres på bestilling).

Best. nr.	D	PN	L	H	EAN/Barcode
Kuglehane med 2 unioner til lim					
PD 010099	16	16	16	78	5704979434600
PD 010100	20	16	16	78	5704979434617
PD 010101	25	16	19	90	5704979434624
PD 010102	32	16	22	104	5704979434631
PD 010103	40	16	26	120	5704979434648
PD 010104	50	16	31	140	5704979434655
PD 010105	63	16	38	169	5704979434662
PD 010106	75	16	44	227	5704979434679
PD 010107	90	16	51	242	5704979434686
PD 010108	110	16	61	282	5704979434693
PD 011080	25	10	19	90	5704979434709
PD 011081	32	10	22	104	5704979434716
PD 011082	40	10	26	120	5704979434723
PD 011083	50	10	31	140	5704979434730
PD 011084	63	10	38	169	5704979434747

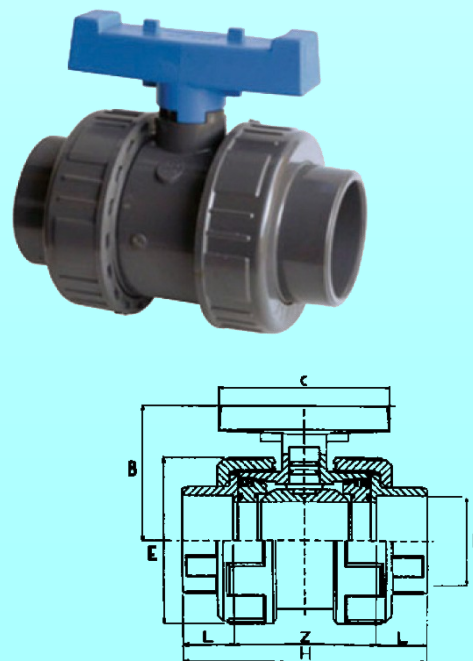

- Kuglehaner i høj kvalitet. Kuglen er på begge sider er sikret imod udfald.
- O-ring EPDM 70 SH. Pakninger: PTFE (Teflon).
- Pakninger kan leveres i Viton på bestilling.
- Arbejdstryk (til 63 mm.): 16 bar, arbejdstryk (fra 75 mm.): 10 bar.
- Farve håndtag: orange.

Best. nr.	D	L	Z	EAN/Barcode
Industri - kuglehaner med 2 unioner				
PD 020170	16	16	46	5704979434785
PD 020171	20	16	46	5704979434792
PD 020172	25	19	52	5704979434808
PD 020173	32	22	60	5704979434815
PD 020174	40	26	68	5704979434822
PD 020175	50	31	78	5704979434839
PD 020176	63	38	93	5704979434846
PD 020177	75	44	139	5704979434853
PD 020178	90	51	139	5704979434860
PD 020179	110	61	160	5704979434877

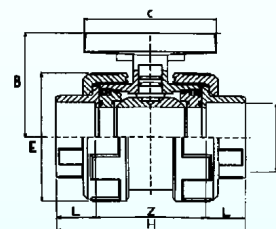

Kugleventil med overgang til PE spændkobling

- O-ring: EPDM
- Kugleindsats: PTFE (Teflon)
- Arbejdstryk: maks. 16 bar ved 20° C.

Best. nr.	Størrelse i mm.	EAN/Barcode
Kuglehaner lim & spændkobling		
PD 020210	20 lim x 20 spænd	5704979434907
PD 020211	25 lim x 25 spænd	5704979434914
PD 020212	32 lim x 32 spænd	5704979434921



- T-boring af kuglen, O-ring: EPDM, kugleindsats: PTFE (Teflon).
- Arbejdstryk: 10 bar ved 20° C.

Best. nr.	D	L	T	N	EAN/Barcode
Kuglehaner 3-vejs T-boring limmuffe					
PD 020231	16	112	45	57	5704979434952
PD 020232	20	112	45	57	5704979434969
PD 020233	25	123	55	62	5704979434976
PD 020234	32	147	66	74	5704979434983
PD 020235	40	169	79	82	5704979434990
PD 020236	50	202	96	106	5704979435003
PD 020237	63	230	111	117	5704979435010

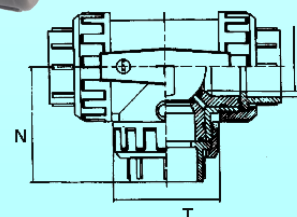

- L-boring af kuglen, O-ring: EPDM, kugleindsats: PTFE (Teflon).
- Arbejdstryk: 10 bar ved 20° C.

Best. nr.	D	L	T	N	EAN/Barcode
Kugleventil 3-vejs L-boring limmuffe					
PD 020240	16	112	45	57	5704979435041
PD 020241	20	112	45	57	5704979435058
PD 020242	25	123	55	62	5704979435065
PD 020243	32	147	66	74	5704979435072
PD 020244	40	169	79	82	5704979435089
PD 020245	50	202	96	106	5704979435096
PD 020246	63	230	111	117	5704979435102

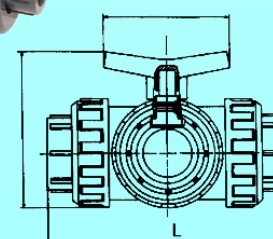

Valterra skydeventil udført i PVC, m. skydestang i rustfrit stål, og 3 stk. O-ringe i toppen.
 Anvendelse: I hoveddamme, svømmebassiner, Whirlpools og tanke.
 Ventilene er forsynet med de nye Santopren pakninger (100 % kemisk resistente), og er egnet til både vakuum og tryk. Ventilene fra 50 - 90 mm. er fremstillet i kunststof, og ventilen i 110 mm. er i rustfrit stål.
 Velegnet til lavtryksanlæg. Det er muligt at forlænge skydestangen.

Best. nr.	Størrelse	Arbejdstryk ved 20° C.	EAN/Barcode
Valterra Skydeventil - 2 x limmuffer			
PI 001200	50 mm.	Maks. 3,5 bar	5704979435140
PI 001210	63 mm.	Maks. 2,8 bar	5704979435157
PI 001220	90 mm.	Maks. 1,4 bar	5704979435164
PI 001230	110 mm.	Maks. 1,0 bar	5704979435171
PI 001290	Forlængelse Alu. 45 cm.	-	5704979435188
PI 001292	Forlængelse Alu. 75 cm.	-	5704979435195
PI 001294	Forlængelse Alu. 100 cm.	-	5704979435201
PI 001295	Forlængelse Rustfri 60 cm.	-	5704979435218



Denne nye model er en prisbillig udgave af Valtterra. God kvalitet hele vejen igennem. Den lille lås på oversiden af 50 mm. ventilen, gør det, med sin udformning, lettere at åbne for hanen, når den er under påvirkning af vakuum.

Best. nr.	Type	Arbejdstryk ved 20° C.	EAN/Barcode
Skydeventil - 2 x limmuffer			
PI 001300	50 mm.	Maks. 2,8 bar	5704979435249
PI 001340	110 mm.	Maks. 0,8 bar	5704979435256

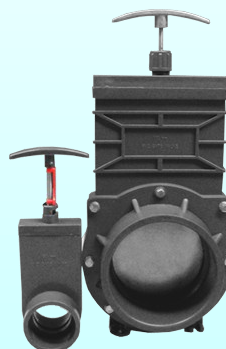

12 V. jævnstrømsmotor, til styring af Valtterra skydeventiler.
 Leveres uden skydeventil.
 Pneumatiske skydeventiler leveres komplet med skydeventil og pneumatisk cylinder.

Best. Nr.	Type	Arbejdstryk ved 20° C.	EAN/Barcode
Skydeventil automatisk			
PI 030115	12 v. drev for 50/63/90 mm.	-	5704979435287
PI 031080	63 mm. pneumatisk	Maks. 2,8 bar	5704979435294
PI 031081	90 mm. pneumatisk	Maks. 1,4 bar	5704979435300



Solid skydeventil med udskiftelig pakning. Vandtæt i alle positioner og kan lukke i alle positioner. Nem udskiftelig pakning, placeret ved betjeningsakslen.
 Model 110 mm. har kappe af PVC og 160/200 mm. har kappe i rustfrit stål.

Best. nr.	Type (mm.)	Arbejdstryk ved 20° C.	EAN/Barcode
Skydeventil VDL			
PI 040070	110	Maks. 1,0 bar	5704979435331
PI 040071	160	Maks. 1,0 bar	5704979435348
PI 041072	200	Maks. 0,6 bar	5704979435355

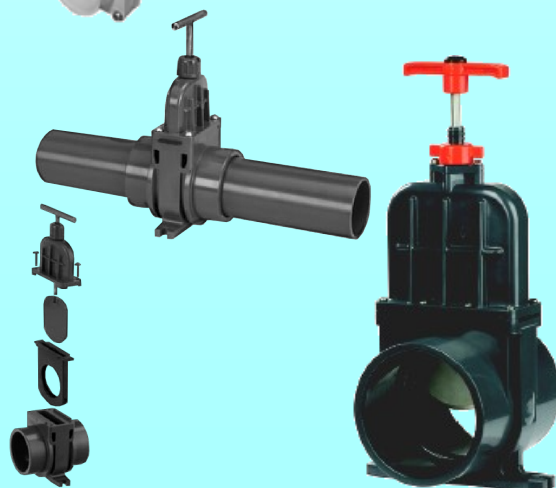

Kan på bestilling leveres i 12-24-48-110 V.. Leveringstid: 1 uge fra ordre.
 Data: Se kode AD170-179, leveres også i Viton
 Forskelligt tilbehør kan leveres: f. eks. elektrisk opvarmning til servomotor.
 Komplet med fjernbetjening, positionsvisning og 2 endestop-kontakter.

Best. nr.	Størrelse	V. / spænding	EAN/Barcode
Kuglehane PVC el-drev type EBK			
PD 040900	50 mm.	24 V. AC/DC	5704979435386
PD 040901	50 mm.	230 V. AC	5704979435393
PD 040902	63 mm.	24 V. AC/DC	5704979435409
PD 040903	63 mm.	230 V. AC	5704979435416



DOBBELTARBEJDENDE

- Data: Se kode AD170-179, leveres også i Viton.
 - Pneumatisk drift i høj kvalitet.
 - Forskelligt tilbehør kan leveres: f.eks. Kontrol/sikkerhedsboks, 3V-ventil.
 - Leveringstid: 1 uge fra ordre.

Best. nr.	Størrelse	V. / spænding	EAN/Barcode
Kuglehane PVC pneumatisk drev			
PD 040910	50 mm.	12/48 V. AC/DC	5704979435492
PD 040911	50 mm.	80/240 V. AC/DC	5704979435508
PD 040912	63 mm.	12/48 V. AC/DC	5704979435515
PD 040913	63 mm.	80/240 V. AC/DC	5704979435522
PD 040914	75 mm.	12/48 V. AC/DC	5704979435539
PD 040915	75 mm.	80/240 V. AC/DC	5704979435546
PD 040916	90 mm.	12/48 V. AC/DC	5704979435553
PD 040917	90 mm.	80/240 V. AC/DC	5704979435560
PD 040918	110 mm.	12/48 V. AC/DC	5704979435577
PD 040920	110 mm.	80/240 V. AC/DC	5704979435584



Alle former for motorventiler til f.eks. kuglehaner og butterflyventiler fra 50 mm. op til 315 mm. skaffes på forespørgsel.

Den viste ventil klarer kugleventiler fra 63 mm. op til 110 mm.

Den viste ventil klarer butterflyventiler fra 110 mm. op til 250 mm.

Skal det gå rigtigt stærk skaffer vi også gerne pneumatisk ventiler i alle størrelser i bl.a. Aluminium, Rustfrit Stål, Titanium.



Best. nr.	Størrelse	EAN/Barcode
Flydeventil, messing, uden flydebolt		
PS 010260	3/8"	5704979440007
PS 010262	1/2"	5704979440014
PS 010264	3/4"	5704979440021
PS 010266	1"	5704979440038
PS 010268	1-1/4"	5704979440045
PS 010270	1-1/2"	5704979440052
PS 010272	2"	5704979440069



Best. nr.	Størrelse	EAN/Barcode
Flydebolt til fyldeventil		
PS 010280	Ø. 90 mm. (3/8" x 1/2")	5704979440090
PS 010282	Ø.120 mm. (3/4" x 1")	5704979440106
PS 010284	Ø. 150 mm. (1" x 1-1/4")	5704979440113
PS 010286	Ø. 180 mm. (1-1/2" x 2")	5704979440120



Kabinet i polyamid, forstærket med glasfiber.
 NBR gummimembran, kerne og skruer i rustfrit stål.
 Fortryk: 0,4 bar, arbejdsstryk: 0,4 til 10 bar ved 20° C.
 Arbejdstemperatur: maks. +4° C. - +75° C.
 Arbejdsstrøm: 2,2 W., strømforbrug: 185 MA, standard lukket.
 Spole med bajonetlås og håndbetjening.
 Kan monteres i alle positioner. Alle haner er testet!

Best. nr.	Størrelse	Spole	Flow kontrol	Maks. M ³ ved trykfald på 1 bar	EAN/Barcode
Magnetventil RPE - elektrisk					
HS 010620	1/2" indv. gevind	24 VAC	Ja	5,5 m ³ /t.	5704979440182
HS 010622	3/4" udv. gevind	24 VAC	Nej	7,5 m ³ /t.	5704979440199
HS 010624	3/4" indv. gevind	24 VAC	Nej	7,5 m ³ /t.	5704979440205
HS 010625	3/4" indv. gevind mes.	24 VAC	Ja	7,5 m ³ /t.	5704979440212
HS 010626	3/4" indv. gevind	24 VAC	Ja	7,5 m ³ /t.	5704979440229
HS 010628	1" udv. gevind	24 VAC	Nej	11,5 m ³ /t.	5704979440236
HS 010630	1" indv. gevind	24 VAC	Nej	11,5 m ³ /t.	5704979440243
HS 010632	1" indv. gevind	24 VAC	Ja	11,5 m ³ /t.	5704979440250
HS 010633	1" indv. gevind mes.	24 VAC	Ja	11,5 m ³ /t.	5704979440267
HS 010634	1-1/4" udv. gevind	24 VAC	Nej	15,0 m ³ /t.	5704979440274
HS 010636	1-1/4" indv. gevind	24 VAC	Ja	15,0 m ³ /t.	570497944028
HS 010637	1-1/4" indv. gevind mes.	24 VAC	Ja	15,0 m ³ /t.	5704979440298
HS 010638	1-1/2" indv. gevind	24 VAC	ja	25,0 m ³ /t.	5704979440304
HS 010639	1-1/2" indv. gevind mes.	24 VAC	Ja	25,0 m ³ /t.	5704979440311
HS 010640	2" indv. gevind	24 VAC	Ja	50,0 m ³ /t.	5704979440328
HS 010641	2" indv. gevind messing	24 VAC	Ja	50,0 m ³ /t.	5704979440335
HS 010642	3" udv. gevind	24 VAC	Ja	50,0 m ³ /t.	5704979440342

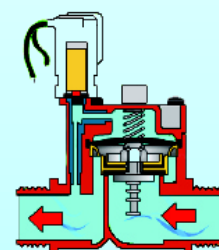
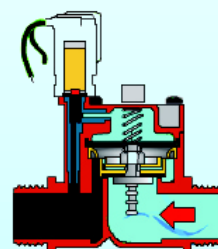



**Høj kvalitets magnetventiler i rustfrit stål leveres i 24 volt AC.
 Alle størrelser kan bestilles i 230 volt udførelse.
 Alle størrelser lukker / åbner på 1,3 sekund.**

Art. no.	Model	Størrelse	Gevind	Vægt	EAN/Barcode
HS 021000	Magnet ventil ACX 1	1/2"	2 x 1/2" indvendigt	0,41 kg.	5704979490415
HS 021005	Magnet ventil ACX 2	3/4"	2 x 3/4" indvendigt	0,52 kg.	5704979490422
HS 021010	Magnet ventil ACX 3	1"	2 x 1" indvendigt	0,86 kg.	5704979490439
HS 021015	Magnet ventil ACX 4	1-1/4"	2 x 1-1/4" indvendigt	1,21 kg.	5704979490446
HS 021020	Magnet ventil ACX 5	1-1/2"	2 x 1-1/2" indvendigt	1,45 kg.	5704979490453
HS 021025	Magnet ventil ACX 6	2"	2 x 2" indvendigt	2,32 kg.	5704979490460

Flyderen i ventilen sørger for udluftning. Vandtrykket lukker ventilen.

- O-ringe: EPDM.
- Arbejdstryk (20 til 63 mm.): 16 bar ved 20° C.
- Arbejdstryk (75 til 110 mm.): 10 bar ved 20° C.

Best. nr.	D	L	Z	H	E	EAN/Barcode
Udluftningsventil						
PB 200180	20	16	46	78	50	5704979435942
PB 200181	25	19	52	90	60	5704979435959
PB 200182	32	22	60	104	68	5704979435966
PB 200183	40	26	68	120	80	5704979435973
PB 200184	50	31	78	140	94	5704979435980
PB 200185	63	38	93	169	115	5704979435997
PB 200186	75	44	139	227	168	5704979436000
PB 200187	90	51	139	242	168	5704979436017
PB 200188	110	61	160	282	210	5704979436024

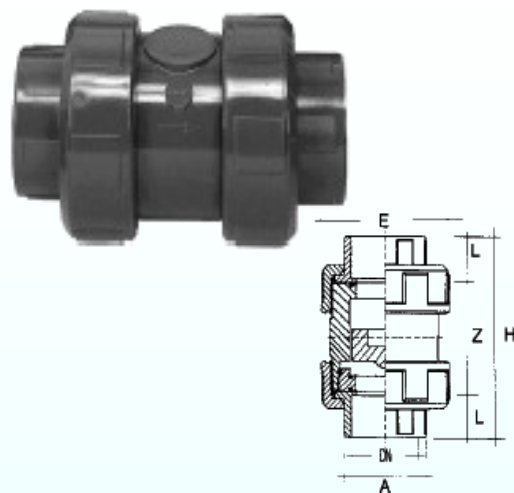

- O-ringe: FMP (Viton).
- Viton pakninger har en større kemisk resistens.
- Ellers data som ovenover.

Best. nr.	D	L	Z	H	E	EAN/Barcode
Viton tilbageløbsventil PVC						
PB 200260	20	16	46	78	50	5704979436055
PB 200261	25	19	52	90	60	5704979436062
PB 200262	32	22	60	104	68	5704979436079
PB 200263	40	26	68	120	80	5704979436086
PB 200264	50	31	78	140	94	5704979436093
PB 200265	63	38	93	169	115	5704979436109
PB 200266	75	44	139	227	168	5704979436116
PB 200267	90	51	139	242	168	5704979436123
PB 200268	110	61	160	282	210	5704979436130

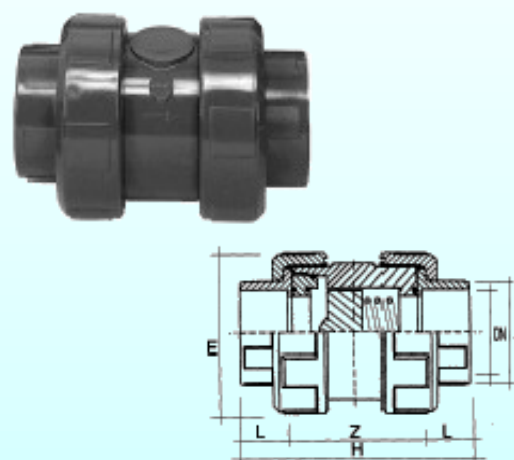

- Ventilen kan ved lodret montering anvendes uden fjeder.
- Den ene muffe kan evt. erstattes af en filterkurv (se næste side).
- O-ringe: EPDM (Teflon), Fjeder: fremstillet i rustfrit stål.
- Arbejdstryk (20 til 63 mm.): 16 bar ved 20° C.
- Arbejdstryk (75 til 110 mm.): 10 bar ved 20° C.

Best. nr.	D	L	Z	H	E	EAN/Barcode
Tilbageløbsventil PVC & Teflon						
PB 200140	20	16	46	78	50	5704979436161
PB 200141	25	19	52	90	60	5704979436178
PB 200142	32	22	60	104	68	5704979436185
PB 200143	40	26	68	120	80	5704979436192
PB 200144	50	31	78	140	94	5704979436208
PB 200145	63	38	93	169	115	5704979436215
PB 200146	75	44	139	227	168	5704979436222
PB 200147	90	51	139	242	168	5704979436239
PB 200148	110	61	160	282	210	5704979436246



Filterkurven kan monteres i stedet for tilbageløbsventilens ene limmuffe.

Best. nr.	D	EAN/Barcode
Filterkurv til kugleventil/union m.v.		
PB 200150	20	5704979436277
PB 200151	25	5704979436284
PB 200152	32	5704979436291
PB 200153	40	5704979436307
PB 200154	50	5704979436314
PB 200155	63	5704979436321
PB 200156	75/90	5704979436338
PB 200158	110	5704979436345

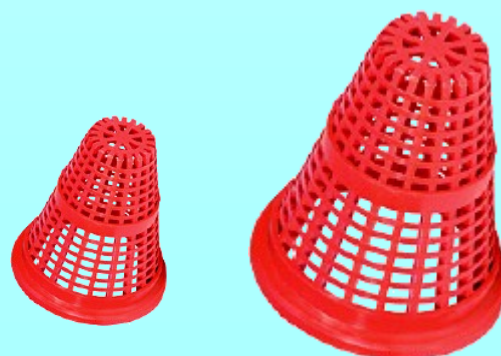

Meget pålidelig kontraventil, leveres med/uden fjeder - minimal modstand. Forureninger opdages hurtigt i det transparente kabinet. Let at rengøre.

- Monteres vertikal med fjeder
- Monteres horisontal uden fjeder.

Best. nr.	Type	EAN/Barcode
Valterra tilbageløbsventil transparent		
PB 210620	Kontraventil u. fjeder, 2 x unioner 50 mm.	5704979436383
PB 210616	Kontraventil m. fjeder, 2 x unioner 50 mm.	5704979436390
PB 210622	Kontraventil u. fjeder, 2 x unioner 63 mm.	5704979436406
PB 210618	Kontraventil m. fjeder, 2 x unioner 63 mm.	5704979436413



- Hængende kontraventil, med minimalt tryktab!
- Monteres mellem flangebøsningerne.
- Mindste afstand til pumpen er lig med 5 x rørdiameter.

Best. nr.	D	A	B	C	EAN/Barcode
Kontraventil PVC					
PB 200280	75	129	20	40	5704979436444
PB 200281	90	144	20	52	5704979436451
PB 200282	110	164	23	70	5704979436468
PB 200283	125	170	25	83	5704979436475
PB 200284	140	195	24	92	5704979436482
PB 200285	160	220	26	112	5704979436499
PB 200286	200	247	28	139	5704979436505
PB 200287	225	275	34	150	5704979436512

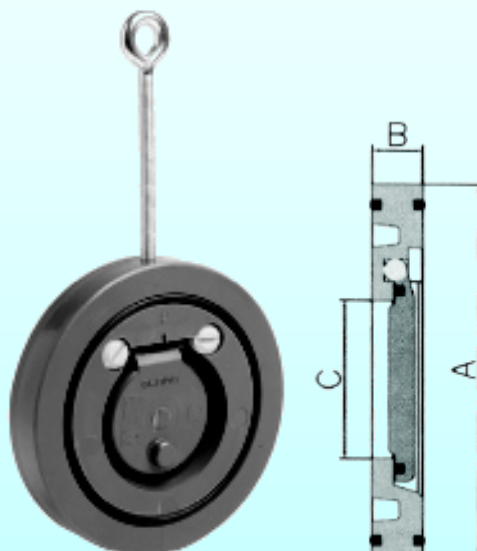

- Intet tryktab.
- Små dimensioner.
- Pakning rundt omkring ventilen.
- Pakning: EPDM, leveres også i Viton på bestilling.
- Arbejdstryk (til 140 mm.): maks. 10 bar ved 20° C.
- Arbejdstryk (fra 140 mm.): maks. 6 bar ved 20° C.
- Arbejdstemperatur: maks. 60° C.

Best. nr.	D	DN	A	B	C	E	S	G	F	I	M	EAN/Barcode	
Butterfly-ventil i PVC													
PD 050200	63/75	65	2½"	129,5	165	110	27,5	60	10	18	125	228	5704979436543
PD 050201	90	80	3"	233	130	123	31	57	11	18	160	240	5704979436550
PD 050202	110	100	4"	253	152	143	31	58	11	18	180	240	5704979436567
PD 050203	125	125	5"	264	170	148	31	62	11	18	190	240	5704979436574
PD 050204	140	125	5"	284	185	159	31	63	11	18	210	240	5704979436581
PD 050205	160	150	6"	312	216	169	31	73	14	22	240	340	5704979436598
PD 050206	200	200	8"	370	273	200	31	83	14	22	295	340	5704979436604

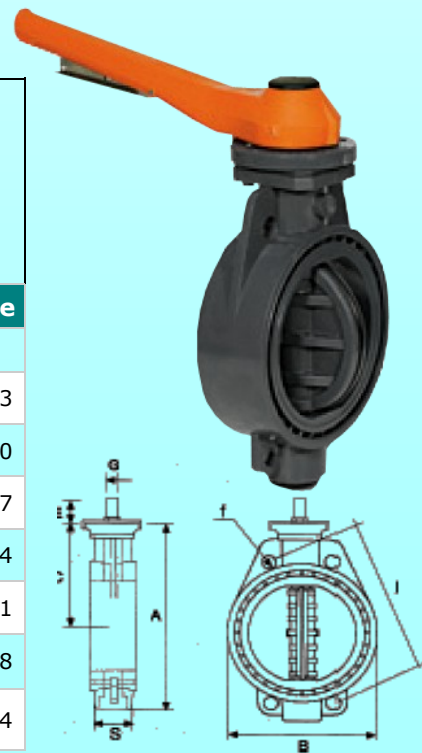

Best. nr.	D	DN	L	Z	d	S	E	EAN/Barcode
Limflange 16 bar								
Gummitætning til flange - se de følgende sider.								
PD 010400	20	15	16	3	27	6	34	5704979436635
PD 010401	25	20	19	3	33	7	41	5704979436642
PD 010402	32	25	22	3	41	7	50	5704979436659
PD 010403	40	32	26	3	50	8	61	5704979436666
PD 010404	50	40	31	3	61	8	73	5704979436673
PD 010405	63	50	38	3	76	9	90	5704979436680
PD 010406	75	65	44	3	90	10	106	5704979436697
PD 010407	90	80	51	5	107	11	125	5704979436703
PD 010408	110	100	61	5	131	12	150	5704979436710
PD 010409	125	110	74	5	146	12	168	5704979436727
PD 010410	140	125	78	4	163	13	188	5704979436734
PD 010411	160	150	85,5	6	185	13	213	5704979436741
PD 010412	200	200	106	6,5	232	18	254	5704979436758
PD 010413	225	200	119	7	248	19	274	5704979436765
PD 010414	250	225	131	9	279	20	308	5704979436772
PD 010415	315	300	165	16	346	32	377	5704979436789

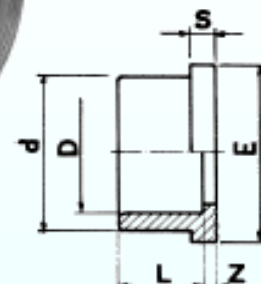

Best. Nr.	D	DN	d	E	S	I	Huller	EAN/Barcode
Spændflange 16 bar								
Gummitætning til flange - se de følgende sider.								
PD 020420	20	15	28	95	11	65	4	5704979436826
PD 020421	25	20	34	105	12	75	4	5704979436833
PD 020422	32	25	42	115	14	85	4	5704979436840
PD 020423	40	32	51	140	15	100	4	5704979436857
PD 020424	50	40	62	150	16	110	4	5704979436864
PD 020425	63	50	78	165	18	125	4	5704979436871
PD 020426	75	65	92	185	19	145	4	5704979436888
PD 020427	90	80	110	200	20	160	8	5704979436895
PD 020428	110	100	133	220	22	180	8	5704979436901
PD 020429	125	110	149	230	24	190	8	5704979436918
PD 020431	140	125	167	250	26	210	8	5704979436925
PD 020432	160	150	190	285	28	240	8	5704979436932
PD 020433	200	200	235	340	30	295	8	5704979436949
PD 020434	225	200	250	340	30	295	8	5704979436956
PD 020435	250	250	285	390	35	350	8	5704979436963
PD 020436	315	300	349	465	40	400	12	5704979436970

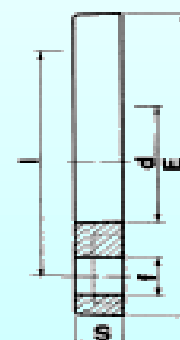
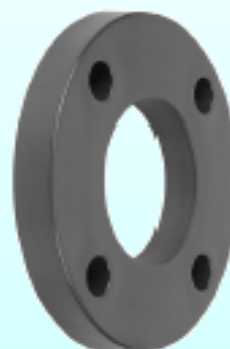

Best. Nr.	D	DN	E	S	I	Huller	EAN/Barcode
Blindflange 16 bar							
Gummitætning til blindflange - se de følgende sider.							
Ved Størrelse 200 mm. Vær opmærksom på bolthul-målene !!							
PD 030440	20	15	95	11	65	4	5704979437014
PD 030441	25	20	105	12	75	4	5704979437021
PD 030442	32	25	115	14	85	4	5704979437038
PD 030443	40	32	140	15	100	4	5704979437045
PD 030444	50	40	150	16	110	4	5704979437052
PD 030445	63	50	165	18	125	4	5704979437069
PD 030446	75	65	185	19	145	4	5704979437076
PD 030447	90	80	200	20	160	8	5704979437083
PD 030448	110	100	220	22	180	8	5704979437090
PD 030449	125	110	230	24	190	8	5704979437106
PD 030450	140	125	250	26	210	8	5704979437113
PD 030451	160	150	285	28	240	8	5704979437120
PD 030452	200	200	315	36	270	8	5704979437137
PD 030453	200/225	225	340	36	295	8	5704979437144
PD 030454	250	250	370	36	325	8	5704979437151
PD 030455	250/280	280	395	36	350	12	5704979437168
PD 030456	315	315	445	36	400	12	5704979437175

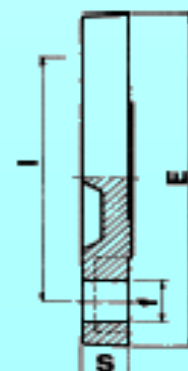

Best. nr.	Størrelse	D	S	EAN/Barcode
Pakning til 3/3 flange - NBR gummi				
PB 170500	16	15,5	2,6	5704979440380
PB 170501	20	20,2	3,5	5704979440397
PB 170502	25	28,2	3,5	5704979440403
PB 170503	32	32,9	3,5	5704979440410
PB 170504	40	40,6	5,3	5704979440427
PB 170505	50	47	5,3	5704979440434
PB 170506	63	59,7	5,3	5704979440441
PB 170507	75	78,7	5,3	5704979440458
PB 170508	90	91,4	5,3	5704979440465
PB 170509	110	113,7	5,3	5704979440472

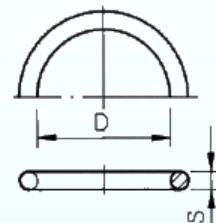

Best. nr.	Størrelse	D	S	EAN/Barcode
Pakning til 3/3 flange - Vitron (FPM)				
PB 170520	16	15,5	2,6	5704979440519
PB 170521	20	20,2	3,5	5704979440526
PB 170522	25	28,2	3,5	5704979440533
PB 170523	32	32,9	3,5	5704979440540
PB 170524	40	40,6	5,3	5704979440557
PB 170525	50	47,0	5,3	5704979440564
PB 170526	63	59,7	5,3	5704979440571

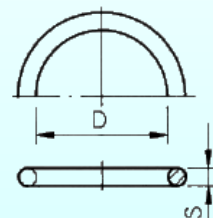

Best. nr.	Størrelse	d	D	S	Type	EAN/Barcode
Fladpakning til bøsninger						
PB 170540	20	18	32	2	A	5704979440618
PB 170541	25	22	39	2	A	5704979440625
PB 170542	32	28	48	2	A	5704979440632
PB 170543	40	35	59	2	A	5704979440649
PB 170544	50	45	71	3	A	5704979440656
PB 170545	63	60	88	3	A	5704979440663
PB 170546	75	70	104	3	A	5704979440670
PB 170547	90	85	123	3	A	5704979440687
PB 170548	110	105	148	4	A	5704979440694
PB 170549	125	120	168	4	A	5704979440700
PB 170550	140	135	186	4	A	5704979440717
PB 170551	160	155	211	4	A	5704979440724
PB 170552	200	190	248	5	B	5704979440731
PB 170553	225	215	273	5	B	5704979440748
PB 170554	250	238	303	5	B	5704979440755
PB 170556	315	300	378	5	B	5704979440762

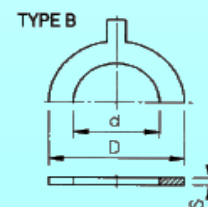
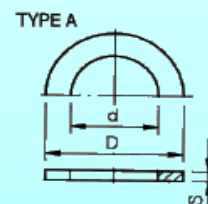

Best. nr.	Gevindstørrelse	d	D	S	EAN/Barcode
Fladpakning med profiler					
Gummiring med stående profil for en bedre tætning.					
PB 170620	1/2"	20	30	2	5704979440809
PB 170621	3/4"	26	36	2	5704979440816
PB 170622	1"	33	43	2	5704979440823

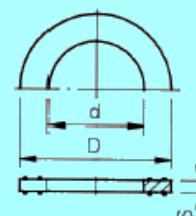

Best. nr.	Størrelse	d	D	S	EAN/Barcode
Fiberringe til beholdergennemførsler					
PB 171580	3/4"	29	39	3	5704979440861
PB 172579	1"	34	46	2	5704979440878
PB 172581	1"	34	48	3	5704979440885
PB 172582	1-1/4"	42	58	3	5704979440892
PB 172583	1-1/2"	48	65	3	5704979440908
PB 172584	1-3/4"	55	72	4	5704979440915
PB 172585	2"	61	79	4	5704979440922
PB 172586	2-1/4"	67	86	4	5704979440939
PB 172587	2-1/2"	77	94	4	5704979440946
PB 172588	3"	90	112	5	5704979440953
PB 172589	M113 + 4"	115	140	5	5704979440960

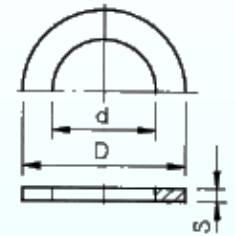

Best. nr.	Kappe + 3/3 union	Ekstern gevind	d	D	S	Type	EAN/Barcode
Fladpakning til endekapper/unioner							
PB 173560	3/8"	-	-	14	2	A	5704979441004
PB 173561	1/2"	-	-	18,5	2	A	5704979441011
PB 173562	3/4"	-	-	24	2	A	5704979441028
PB 173563	1"	-	18,5	30	2	B	5704979441035
PB 173572	-	1/2"	22	33	2	B	5704979441042
PB 174564	1-1/4"	3/4"	29	39	2	B	5704979441059
PB 174565	1-1/2"	1"	34	45	3	B	5704979441066
PB 174566	2"	1-1/4"	44	57	3	B	5704979441073
PB 174567	2-1/2"	1-3/4" + 2"	57	73	4	B	5704979441080
PB 174568	3"	2-1/4"	67	85	4	B	5704979441097
PB 174569	-	2-1/2"	77	95	4	B	5704979441103
PB 174570	4"	3"	88	110	5	B	5704979441110
PB 174571	-	M113	115	135	5	B	5704979441127

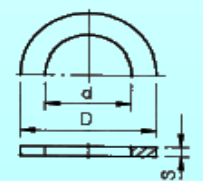
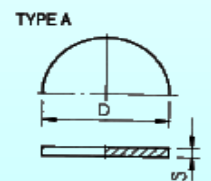

Best. nr.	Gevind størrelse	d	D	S	Størrelse studs	EAN/Barcode
Fladpakning til slangestuds med indvendigt gevind						
PB 175600	3/4"	11	23	2	16	5704979441165
PB 175601	1"	15	29	2	20	5704979441172
PB 175602	1-1/4"	19	37	2	25	5704979441189
PB 175603	1-1/2"	24	43	3	32	5704979441196
PB 175604	2"	32	55	3	40	5704979441202
PB 175605	2-1/4"	40	61	3	50	5704979441219
PB 175606	2-3/4"	50	77	3	63	5704979441226

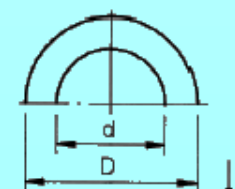

Best. nr.	d1/d2 x d1	d3	EAN/Barcode
Beholder/tankgennemføring			
PC 010520	16 x 16	1/2"	5704979437212
PC 010521	20/25 x 20	3/4"	5704979437229
PC 010522	25/32 x 25	1"	5704979437236
PC 010523	32/40 x 32	1-1/4"	5704979437243
PC 010524	40/50 x 40	1-3/4"	5704979437250
PC 010525	50/63 x 50	2"	5704979437267
PC 010526	50/63 x 50	2-1/4"	5704979437274
PC 010527	63/75 x 63	2-1/2"	5704979437281
PC 010528	75/90 x 75	3"	5704979437298
PC 010529	90/110 x 90	M113	5704979437304
PC 010530	110/125 x 110	M113	5704979437311

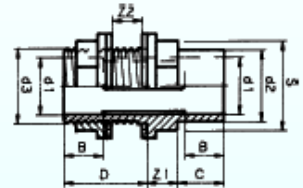

Best. nr.	Str. (d1)	d3	Z1	C	Z2	EAN/Barcode
Beholder/tankgennemføring VDL						
Fremstillet med lavt afløb på 6-6 mm. via afløbshuller på 5 mm.						
PC 020540	16	3/4"	11	5	0-28	5704979437359
PC 020541	20	1"	12	5	0-28	5704979437366
PC 020542	25	1-1/4"	13	5	0-28	5704979437373
PC 020543	32	1-1/2"	13	5	0-28	5704979437380
PC 020544	40	2"	13	6	0-29	5704979437397
PC 020545	50	2-1/4"	15	6	0-30	5704979437403
PC 020546	63	2-3/4"	15	6	0-35	5704979437410

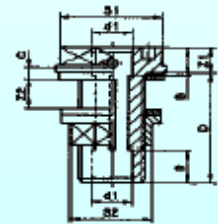

Best. nr.	D	PN	L	Z1	Z2	F	EAN/Barcode
3/3 Union 16 bar lim/lim med O-ring							
PA 130248	10	16	12	-	-	23	5704979437458
PA 130249	12	16	12	-	-	23	5704979437465
PA 130250	16	16	14	3	10	3/4"	5704979437472
PA 130251	20	16	16	3	10	1"	5704979437489
PA 130252	25	16	19	3	10	1-1/4"	5704979437496
PA 130253	32	16	22	3	10	1-1/2"	5704979437502
PA 130254	40	16	26	3	12	2"	5704979437519
PA 130255	50	16	31	3	14	2-1/4"	5704979437526
PA 130256	63	16	38	3	18	2-3/4"	5704979437533
PA 130257	75	16	44	3	18	3-1/2"	5704979437540
PA 130258	90	16	51	5	18	4"	5704979437557
PA 130259	110	16	61	5	18	5"	5704979437564
PA 130879	25	10	19	3	10	1-1/4"	5704979437571
PA 130880	32	10	22	3	10	1-1/2"	5704979437588
PA 130881	40	10	26	3	12	2"	5704979437595
PA 130882	50	10	31	3	14	2-1/4"	5704979437601
PA 130883	63	10	38	3	18	2-3/4"	5704979437618

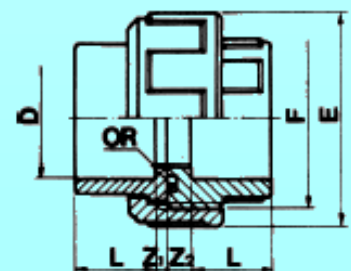

Best. nr.	D x G	L1	L2	Z1	Z2	E	EAN/Barcode
3/3 Union 16 bar lim x indiv.-gev.							
PB 030239	12 x 1/4"	12	12	-	-	-	5704979437649
PB 030240	16 x 3/8"	14	11,4	3	13,6	34	5704979437656
PB 030241	20 x 1/2"	16	15	3	11	42	5704979437663
PB 030242	25 x 3/4"	19	16,3	3	12,7	52	5704979437670
PB 030243	32 x 1"	22	19,1	3	12,9	59	5704979437687
PB 030244	40 x 1-1/4"	26	21,4	3	16,6	72	5704979437694
PB 030245	50 x 1-1/2"	31	21,4	3	23,6	79	5704979437700
PB 030246	63 x 2"	38	25,7	3	30,3	96	5704979437717
PB 030247	75 x 2-1/2"	44	30,8	3	31,8	119	5704979437724
PB 030248	90 x 3"	51	33,3	5	35,7	134	5704979437731
PB 030249	110 x 4"	61	39,3	5	39,7	163	5704979437748

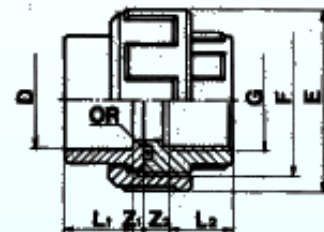

Best. nr.	d1 x d2	EAN/Barcode
3/3 Kobling 16 bar udvendigt gevind		
* = Max. Arbejdstryk 10 bar ved 20°		
PB 030330	12 x 1/4"	5704979437786
PB 030331	16 x 3/8"	5704979437793
PB 031320	20 x 1/2"	5704979437809
PB 031321	25 x 3/4"	5704979437816
PB 031322	32 x 1"	5704979437823
PB 031323	40 x 1-1/4"	5704979437830
PB 031324	50 x 1-1/2"	5704979437847
PB 031326	63 x 2"	5704979437854
PB 031327	*75 x 2-1/2"	5704979437861
PB 031328	*90 x 3"	5704979437878
PB 031329	*110 x 4"	5704979437885

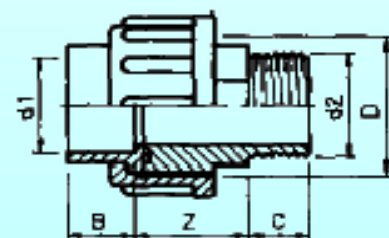

Best. nr.	G	L	F	E	EAN/Barcode
3/3 Union 16 bar 2 x indvendigt gevind + O-ring					
PB 140440	3/8"	11,4	3/4"	34	5704979437922
PB 140441	1/2"	15	1"	42	5704979437939
PB 140442	3/4"	16,3	1-1/4"	52	5704979437946
PB 140443	1"	19,1	1-1/2"	59	5704979437953
PB 140444	1-1/4"	21,4	2"	72	5704979437960
PB 140445	1-1/2"	21,4	2-1/4"	79	5704979437977
PB 140446	2"	25,7	2-3/4"	96	5704979437984
PB 140447	2-1/2"	30,2	3-1/2"	119	5704979437991
PB 140448	3"	33,3	4"	134	5704979438004
PB 140449	4"	39,3	5"	163	5704979438011

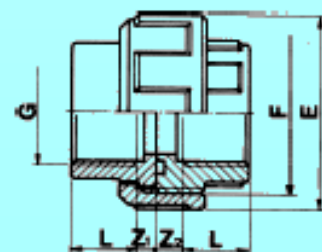

Best. nr.	D x D x G	L1	L2	L3	H	O	EAN/Barcode
Overgangsmuffe 16 bar lim x udvendigt gevind							
PB 040095	10 x 16 x 1/4"	12	12	12	30	19	5704979438059
PB 040096	12 x 16 x 1/4"	12	12	12	30	19	5704979438066
PB 040099	12 x 16 x 3/8"	12	14	11,4	36	22	5704979438073
PB 040100	16 x - x 1/4"	-	14	12	31	27	5704979438080
PB 040101	16 x 20 x 3/8"	14	16	11,4	40	24	5704979438097
PB 040102	16 x 20 x 1/2"	14	16	15	43	24	5704979438103
PB 040103	20 x 25 x 3/8"	16	19	11,4	43	30	5704979438110
PB 040104	20 x 25 x 1/2"	16	19	15	46	30	5704979438127
PB 040105	20 x 25 x 3/4"	16	19	16,3	47	30	5704979438134
PB 040106	25 x 32 x 1/2"	19	22	15	49	36	5704979438141
PB 040107	25 x 32 x 3/4"	19	22	16,3	50	36	5704979438158
PB 040108	25 x 32 x 1"	19	22	19,1	53	36	5704979438165
PB 041097	32 x 40 x 1/2"	22	22	19	49	46	5704979438172
PB 041109	32 x 40 x 3/4"	22	26	16,3	54	46	5704979438189
PB 041110	32 x 40 x 1"	22	26	19,1	57	46	5704979438196
PB 041111	32 x 40 x 1-1/4"	22	26	21,4	60	46	5704979438202
PB 041112	40 x 50 x 1"	26	31	19,1	64	55	5704979438219
PB 041113	40 x 50 x 1-1/4"	26	31	21,4	67	55	5704979438226
PB 041114	40 x 50 x 1-1/2"	26	31	21,4	67	55	5704979438233
PB 042098	50 x 63 x 1"	31	31	21	63	65	5704979438240
PB 042115	50 x 63 x 1-1/4"	31	38	21,4	74	65	5704979438257
PB 042116	50 x 63 x 1-1/2"	31	38	21,4	74	65	5704979438264
PB 042117	50 x 63 x 2"	31	38	25,7	78	65	5704979438271
PB 042118	63 x 75 x 1-1/2"	38	38	21,4	80	80	5704979438288
PB 042119	63 x 75 x 2"	38	44	25,7	84	80	5704979438295
PB 042120	63 x 75 x 2-1/2"	38	44	30,2	91	80	5704979438301
PB 042121	75 x 90 x 2"	44	44	25,7	94	95	5704979438318
PB 042122	75 x 90 x 2-1/2"	44	52	30,2	99	95	5704979438325
PB 042123	75 x 90 x 3"	44	52	33,3	102	95	5704979438332
PB 042124	90 x 110 x 2-1/2"	51	52	30,2	110	115	5704979438349
PB 042125	90 x 110 x 3"	51	61	33,3	113	115	5704979438356
PB 042126	90 x 110 x 4"	51	61	39,3	118	115	5704979438363
PB 042127	110 x 125 x 3"	61	66	33,3	115	130	5704979438370
PB 042128	110 x 125 x 4"	61	66	39,3	120	130	5704979438387
PB 042129	110 x - x 5"	61	66	39,3	120	130	5704979438394

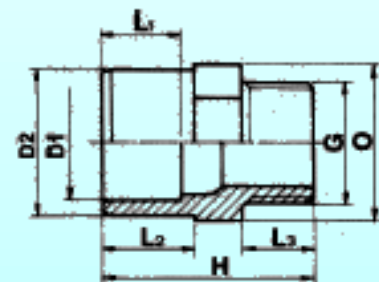

Best. nr.	d1/d2 x d3	C	D	EAN/Barcode
Overgangsmuffe 16 bar lim x udvendigt gevind				
* = Max. Arbejdstryk 10 bar ved 20°				
PB 050100	25 x 1/2"	-	13	5704979438431
PB 050101	25 x 3/4"	-	13	5704979438448
PB 050133	25/32 x 1"	22	19	5704979438455
PB 051102	32 x 1/2"	-	19	5704979438462
PB 051103	32 x 3/4"	-	13	5704979438479
PB 051104	32 x 1"	-	15	5704979438486
PB 051134	32/40 x 1-1/4"	26	21	5704979438493
PB 052105	40 x 1"	-	15	5704979438509
PB 052106	40 x 1-1/4"	-	19	5704979438516
PB 052107	40 x 1-1/2"	-	21	5704979438523
PB 052108	50 x 1-1/4"	-	21	5704979438530
PB 052109	50 x 1-1/2"	-	21	5704979438547
PB 052110	50 x 2"	-	26	5704979438554
PB 052111	*63 x 1-1/4"	-	19	5704979438561
PB 052112	63 x 1-1/2"	-	21	5704979438578
PB 052113	63 x 2"	-	23	5704979438585
PB 052135	63/75 x 2-1/1"	44	31	5704979438592
PB 053114	*75 x 1-1/4"	-	19	5704979438608
PB 053115	*75 x 1-1/2"	-	21	5704979438615
PB 053116	75 x 2"	-	23	5704979438622
PB 053117	75 x 2-1/2"	-	28	5704979438639
PB 053136	75/90 x 3"	51	34	5704979438646
PB 054118	90 x 2"	-	51	5704979438653
PB 054119	90 x 2-1/2"	-	28	5704979438660
PB 054120	90 x 3"	-	30	5704979438677
PB 054137	90/110 x 4"	61	38	5704979438684
PB 055121	*110 x 2-1/2"	-	28	5704979438691
PB 055122	110 x 3"	-	40	5704979438707
PB 055123	110 x 4"	-	28	5704979438714
PB 055124	125 x 3"	-	28	5704979438721
PB 055125	125 x 4"	-	28	5704979438738
PB 055138	125/140 x 5"	76	44	5704979438745
PB 056126	140 x 4"	-	38	5704979438752
PB 056127	140 x 5"	-	40	5704979438769
PB 056139	140/160 x 6"	76	44	5704979438776
PB 056128	160 x 4"	-	36	5704979438783
PB 056129	160 x 5"	-	38	5704979438790
PB 056130	160 x 6"	-	40	5704979438806
PB 056131	*200 x 6"	-	40	5704979438813
PB 056132	*200 x 8"	-	55	5704979438820

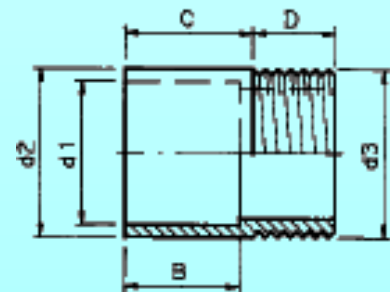
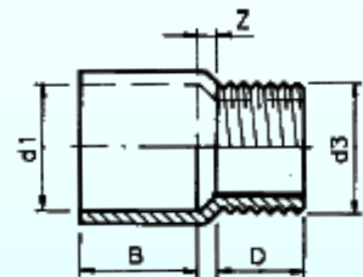

Best. nr.	D x G	L1	L2	Z	E	EAN/Barcode
Gevindmuffe 16 bar indvendigt gevind						
PB 060151	10/16 x 1/4"	12	10	4	24	5704979438868
PB 060152	12 x 1/4"	12	10	4	24	5704979438875
PB 060153	12/16 x 3/8"	12	10	4	24	5704979438882
PB 060154	16 x 1/4"	14	15	3	27	5704979438899
PB 061140	16 x 3/8"	14	11,4	6	23	5704979438905
PB 061141	20 x 1/2"	16	15	4	28	5704979438912
PB 062135	25 x 1/2"	19	18	5	36	5704979438929
PB 062142	25 x 3/4"	19	16,3	6	34	5704979438936
PB 063136	32 x 1/2"	22	18	6	46	5704979438943
PB 063137	32 x 3/4"	22	18	6	46	5704979438950
PB 063143	32 x 1"	22	19,1	6	42	5704979438967
PB 064139	40 x 3/4"	26	16	6	55	5704979438974
PB 064138	40 x 1"	26	23	3	55	5704979438981
PB 064144	40 x 1-1/4"	26	21,4	8	50,5	5704979438998
PB 065155	50 x 1"	31	22	2	66	5704979439001
PB 065156	50 x 1-1/4"	31	23	4	66	5704979439018
PB 066145	50 x 1-1/2"	31	21,4	13	61	5704979439025
PB 066157	63 x 1-1/2"	38	25	7	80	5704979439032
PB 067146	63 x 2"	38	25,7	15	75	5704979439049
PB 067147	75 x 2-1/2"	44	30,2	8	88,5	5704979439056
PB 067148	90 x 3"	51	33,3	9	106	5704979439063
PB 067150	110 x 4"	61	39,3	10	129	5704979439070

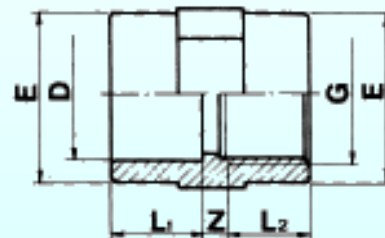

Best. nr.	D x G	L1	L2	Z	E	EAN/Barcode
Gevindmuffe 16 bar indvendigt gevind Forstærkning i rustfrit stål						
PB 068310	16 x 3/8"	14	11,4	6	23	5704979439117
PB 068311	20 x 1/2"	16	15	4	28	5704979439124
PB 068312	25 x 3/4"	19	16,3	6	34	5704979439131
PB 068313	32 x 1"	22	19,1	6	42	5704979439148
PB 068314	40 x 1-1/4"	26	21,4	8	51	5704979439155
PB 068315	50 x 1-1/2"	31	21,4	13	61	5704979439162
PB 068316	63 x 2"	38	25,7	15	75	5704979439179
PB 068317	75 x 2-1/2"	44	33	3	94	5704979439186
PB 068318	90 x 3"	51	36	3	114	5704979439193

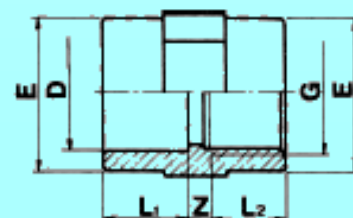

Best. nr.	D x G	L1	L2	Z	E	EAN/Barcode
Reduktionsmuffe 16 bar						
PB 080160	16 x 3/8"	14	11,4	22	23	5704979439230
PB 080161	16 x 1/2"	14	15	22	28	5704979439247
PB 080162	20 x 1/2"	16	15	24	28	5704979439254
PB 080163	20 x 3/4"	16	16,3	24	34	5704979439261
PB 080164	25 x 1/2"	19	15	27	28	5704979439278
PB 080165	25 x 3/4"	19	16,3	27	34	5704979439285
PB 080166	25 x 1"	19	19,1	39	42	5704979439292
PB 080167	32 x 3/4"	22	16,3	30	34	5704979439308
PB 080168	32 x 1"	22	19,1	30	42	5704979439315
PB 080169	40 x 1"	26	19,1	36	42	5704979439322
PB 080170	40 x 1-1/4"	26	21,4	36	51	5704979439339
PB 080171	50 x 1-1/4"	31	21,4	41	55	5704979439346
PB 080172	50 x 1-1/2"	31	21,4	41	58	5704979439353
PB 080173	50 x 2"	31	25,7	41	72	5704979439360
PB 080174	63 x 2"	38	25,7	48	72	5704979439377
PB 080175	75 x 2"	44	25,7	53	72	5704979439384
PB 080176	75 x 2-1/2"	44	30,2	58	89	5704979439391
PB 080177	75 x 3"	44	33,3	58	103	5704979439407
PB 080178	90 x 2-1/2"	51	30,2	65	89	5704979439414
PB 080179	90 x 3"	51	33,3	65	103	5704979439421
PB 080180	90 x 4"	51	39,3	65	130	5704979439438
PB 080181	110 x 3"	61	33,3	76	103	5704979439445
PB 080182	110 x 4"	61	39,3	76	130	5704979439452

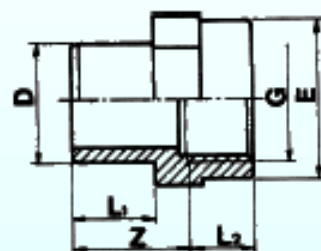

Best. nr.	D x G	L1	L2	Z	E	EAN/Barcode
Reduktionsmuffe lim x indiv. gevind Forstærkning i rustfrit stål						
PB 080330	16 x 3/8"	14	11,4	22	23	5704979439490
PB 080331	20 x 1/2"	16	15	24	28	5704979439506
PB 080332	20 x 3/4"	16	16,3	24	34	5704979439513
PB 080333	25 x 1/2"	19	15	27	28	5704979439520
PB 080334	25 x 3/4"	19	16,3	27	34	5704979439537
PB 080335	25 x 1"	19	19,1	39	42	5704979439544
PB 080336	32 x 3/4"	22	16,3	30	34	5704979439551
PB 080337	32 x 1"	22	19,1	30	42	5704979439568
PB 080338	40 x 1"	26	19,1	36	42	5704979439575
PB 080339	40 x 1-1/4"	26	21,4	36	51	5704979439582
PB 080340	50 x 1-1/4"	31	21,4	41	55	5704979439599
PB 080341	50 x 1-1/2"	31	21,4	41	58	5704979439605

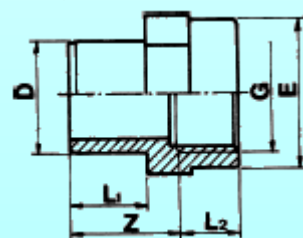

Best. nr.	G	L	Z	E	EAN/Barcode
Gevindmuffe 16 bar 2 x indvendigt gevind					
PB 090099	1/4"	10	6	24	5704979439643
PB 090100	3/8"	11,4	6	23	5704979439650
PB 090101	1/2"	15	7	26,5	5704979439667
PB 090102	3/4"	16,3	7	33	5704979439674
PB 090103	1"	19,1	8	41	5704979439681
PB 090104	1-1/4"	21,4	8	50	5704979439698
PB 090105	1-1/2"	21,4	8	60,5	5704979439704
PB 090106	2"	25,7	8	75	5704979439711
PB 090107	2-1/2"	30,2	9	88	5704979439728
PB 090108	3"	33,3	10	106	5704979439735
PB 090109	4"	39,3	11	129	5704979439742

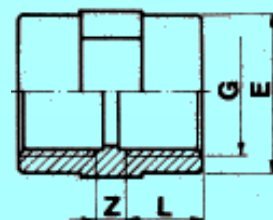

Best. nr.	G x G	L1	L2	Z	EAN/Barcode
Reduktionsmuffe 16 bar 2 x indvendigt gevind					
PB 090159	3/8" x 1/4"	14	10	4	5704979439780
PB 090160	1/2" x 3/8"	15	11,4	6	5704979439797
PB 090161	3/4" x 1/2"	16,3	15	7	5704979439803
PB 090162	1" x 3/4"	19,1	16,3	7	5704979439810
PB 090163	1-1/4" x 1"	21,4	19,1	8	5704979439827
PB 090164	1-1/2" x 1-1/4"	21,4	21,4	8	5704979439834
PB 090165	2" x 1-1/2"	25,7	21,4	8	5704979439841
PB 090166	2-1/2" x 2"	30,2	25,7	8	5704979439858
PB 090167	3" x 2-1/2"	33,3	30,2	9	5704979439865
PB 090168	4" x 3"	39,3	33,3	10	5704979439872

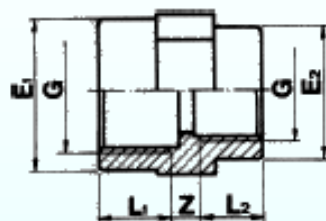

Best. nr.	G udv. x G indv.	L1	L2	Z	E	EAN/Barcode
Reduktions-gevindnippel 16 bar						
PB 140340	3/8" x 1/2"	11,4	15	22	23	5704979439919
PB 140341	1/2" x 3/4"	15	16,3	24	23	5704979439926
PB 140342	3/4" x 1"	16,3	19,1	26	28	5704979439933
PB 140343	1" x 1-1/4"	19,1	21,4	30	23	5704979439940
PB 140344	1-1/4" x 1-1/2"	21,4	21,4	33	28	5704979439957
PB 140345	1-1/2" x 2"	21,4	25,7	34	34	5704979439964
PB 140346	2" x 2-1/2"	25,7	30,2	28	28	5704979439971
PB 140347	2-1/2" x 3"	30,2	33,3	44	34	5704979439988
PB 140348	3" x 4"	33,3	39,3	48	42	5704979439995

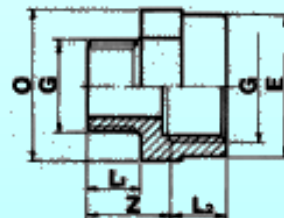

Best. nr.	G udv. x G indv.	L1	L2	Z	O	EAN/Barcode
Reduktion 16 bar udvendigt x indvendigt gevind						
PB 140279	1/2" x 1/4"	-	-	-	-	5704979424991
PB 140280	3/4" x 1/2"	16,3	15	13,3	30	5704979425004
PB 140281	1" x 3/4"	19,1	16,3	14,8	36	5704979425011
PB 140282	1-1/4" x 1"	21,4	19,1	16,3	46	5704979425028
PB 140283	1-1/2" x 1-1/4"	21,4	21,4	14	50	5704979425035
PB 140284	2" x 1-1/2"	25,7	21,4	18,3	65	5704979425042
PB 140285	2-1/2" x 2"	30,2	25,7	20,5	80	5704979425059
PB 140286	3" x 2-1/2"	33,3	30,2	20,1	95	5704979425066
PB 140287	4" x 3"	39,3	33,3	24	120	5704979425073

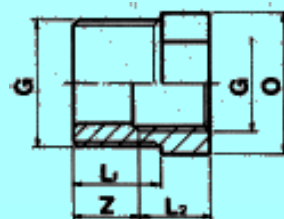
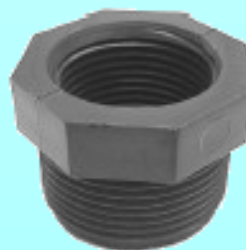

Best. nr.	G	L	H	O	EAN/Barcode
Dobbeltnippel 16 bar 2 x udvendigt gevind					
PB 110179	1/4"	12	32	19	5704979425110
PB 110180	3/8"	11,4	33	22	5704979425127
PB 110181	1/2"	15	42	24	5704979425134
PB 110182	3/4"	16,3	44	30	5704979425141
PB 110183	1"	19,1	50	36	5704979425158
PB 110184	1-1/4"	21,4	58	46	5704979425165
PB 110185	1-1/2"	21,4	58	50	5704979425172
PB 110186	2"	25,7	66	65	5704979425189
PB 110187	2-1/2"	30,2	78	80	5704979425196
PB 110188	3"	33,3	85	95	5704979425202
PB 110189	4"	39,3	96	120	5704979425219

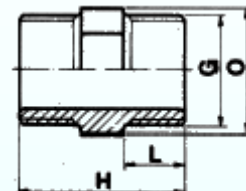

Best. Nr.	G x G	L1	L2	H	O	EAN/Barcode
Reduktionsnippel 16 bar 2 x udvendigt gevind						
PB 110200	1/2" x 3/8"	15	11,4	38	24	5704979425257
PB 110201	3/4" x 1/2"	16,3	15	43	30	5704979425264
PB 110202	1" x 3/4"	19,1	16,3	47	36	5704979425271
PB 110203	1-1/4" x 1"	21,4	19,1	56	46	5704979425288
PB 110204	1-1/2" x 1-1/4"	21,4	21,4	58	50	5704979425295
PB 110205	2" x 1-1/2"	25,7	21,4	62	65	5704979425301
PB 110206	2-1/2" x 2"	30,2	25,7	73	80	5704979425318
PB 110207	3" x 2-1/2"	33,3	30,2	82	95	5704979425325
PB 110208	4" x 3"	39,3	33,3	90	120	5704979425332

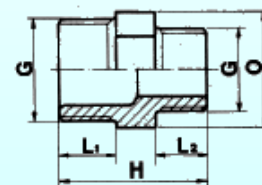

Best. nr.	G udv. x G indv.	L1	L2	Z	E	EAN/Barcode
Gevindnippel 16 bar udvendigt + indvendigt gevind						
PB 140300	1/2" x 3/8"	15	11,4	24	23	5704979425370
PB 140301	3/4" x 3/8"	16,3	11,4	25	23	5704979425387
PB 140302	3/4" x 1/2"	16,3	15	26	28	5704979425394
PB 140303	1" x 3/8"	19,1	11,4	28	23	5704979425400
PB 140304	1" x 1/2"	19,1	15	29	28	5704979425417
PB 140305	1 x 3/4"	19,1	16,3	30	34	5704979425424
PB 140306	1-1/4" x 1/2"	21,4	15	33	28	5704979425431
PB 140307	1-1/4" x 3/4"	21,4	16,3	33	34	5704979425448
PB 140308	1-1/4" x 1"	21,4	19,1	33	42	5704979425455
PB 140309	1-1/2" x 3/4"	21,4	16,3	34	34	5704979425462
PB 140310	1-1/2" x 1"	21,4	19,1	34	42	5704979425479
PB 140311	1-1/2" x 1-1/4"	21,4	21,4	34	51	5704979425486
PB 140312	2" x 1"	25,7	19,1	37	42	5704979425493
PB 140313	2" x 1-1/4"	25,7	21,4	37	51	5704979425509
PB 140314	2" x 1-1/2"	25,7	21,4	37	58	5704979425516
PB 140315	2-1/2" x 1-1/4"	30,2	21,4	43	51	5704979425523
PB 140316	2-1/2" x 1-1/2"	30,2	21,4	43	58	5704979425530
PB 140317	2-1/2" x 2"	30,2	25,7	43	72	5704979425547
PB 140318	3" x 1-1/2"	33,3	21,4	47	58	5704979425554
PB 140319	3" x 2"	33,3	25,7	47	72	5704979425561
PB 140320	3" x 2-1/2"	33,3	30,2	47	89	5704979425578
PB 140321	4" x 2"	39,3	25,7	53	72	5704979425585
PB 140322	4" x 2-1/2"	39,3	30,2	53	89	5704979425592
PB 140323	4" x 3"	39,3	33,3	53	103	5704979425608

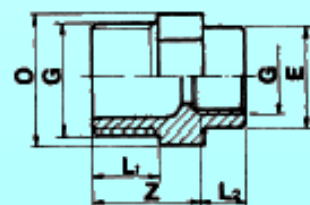

Best. Nr.	Størrelse	Type	EAN/Barcode
Endeprop med indvendigt gevind 16 bar formstøbt			
PB 070347	16 x 1/4"	A	5704979425646
PB 070348	20 x 1/4"	A	5704979425653
PB 070349	20 x 3/8"	A	5704979425660
PB 071346	25 x 3/8"	A	5704979425677
PB 072345	25 x 1/2"	A	5704979425684
PB 072350	25 x 1/2"	B	5704979425691
PB 072351	32 x 1/2"	A	5704979425707
PB 073344	32 x 1/4"	A	5704979425714
PB 073352	32 x 1/4"	B	5704979425721
PB 073353	40 x 1/2"	A	5704979425738
PB 073354	40 x 3/4"	A	5704979425745
PB 073355	40 x 1"	B	5704979425752
PB 073357	50 x 1"	A	5704979425769
PB 073358	50 x 1-1/4"	B	5704979425776
PB 073361	63 x 1-1/2"	B	5704979425783
PB 073364	75 x 2"	B	5704979425790
PB 073367	90 x 2-1/2"	B	5704979425806
PB 073371	110 x 3"	B	5704979425813

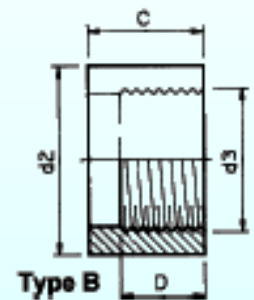
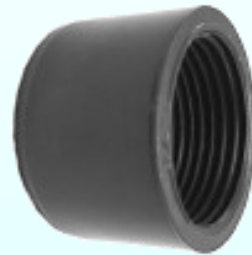
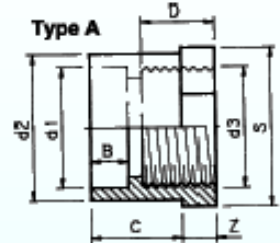

Best. nr.	G	B	EAN/Barcode
Slutmuffe 10 bar indvendigt gevind/pakning			
PB 130240	3/8"	13	5704979425851
PB 130241	1/2"	14	5704979425868
PB 130242	3/4"	16	5704979425875
PB 130243	1"	17	5704979425882
PB 130244	1-1/4"	19	5704979425899
PB 130245	1-1/2"	23	5704979425905
PB 130246	2"	24	5704979425912
PB 130247	2-1/2"	29	5704979425929
PB 130248	3"	31	5704979425936
PB 130249	4"	34	5704979425943

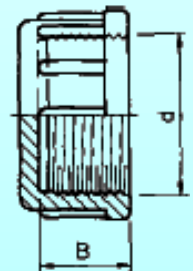

Best. nr.	G	L	H	E	EAN/Barcode
Slutmuffe 16 bar udvendig gevind					
PB 130259	1/4"	12	-	17	5704979425981
PB 130260	3/8"	11,4	24	22	5704979425998
PB 130261	1/2"	15	29	24	5704979426001
PB 130262	3/4"	16,3	30	30	5704979426018
PB 130263	1"	19,1	33	36	5704979426025
PB 130264	1-1/4"	21,4	39	46	5704979426032
PB 130265	1-1/2"	21,4	39	50	5704979426049
PB 130266	2"	25,7	43	65	5704979426056
PB 130267	2-1/2"	30,2	51	80	5704979426063
PB 130268	3"	33,3	55	95	5704979426070
PB 130269	4"	39,3	61	120	5704979426087

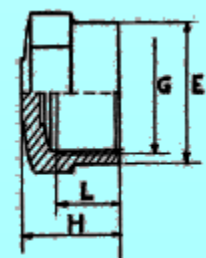
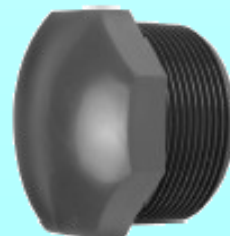

Best. nr.	G	H	D1	D2	EAN/Barcode
Slangestuds 16 bar med udvendigt gevind					
PB 150380	1/4"	53	12	14	5704979426124
PB 150381	3/8"	56	16	18	5704979426131
PB 150382	1/2"	66	20	22	5704979426148
PB 150383	3/4"	71,3	25	27	5704979426155
PB 150384	1"	77,1	30	32	5704979426162
PB 150385	1-1/4"	87,4	40	42	5704979426179
PB 150386	1-1/2"	91,4	50	52	5704979426186
PB 150387	2"	98,7	60	64	5704979426193

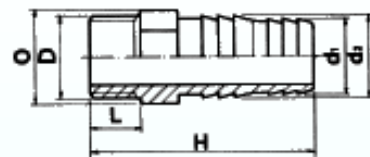

Best. nr.	G	D1	D2	EAN/Barcode
Slangestuds 16 bar indvendigt gevind i omløber				
PB 150400	3/4"	16	18	5704979426230
PB 150401	1"	20	22	5704979426247
PB 150402	1-1/4"	25	27	5704979426254
PB 150403	1-1/2"	30	32	5704979426261
PB 150404	2"	40	42	5704979426278
PB 150405	2-1/4"	50	52	5704979426285
PB 150406	2-3/4"	60	64	5704979426292

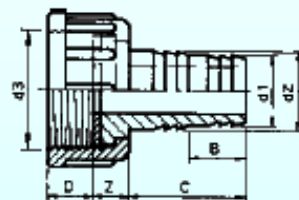

Best. nr.	G	L	Z	E	EAN/Barcode
Vinkel 90° / 16 bar 2 x indvendigt gevind					
PB 100120	3/8"	11,4	11,6	23,5	5704979426339
PB 100121	1/2"	15	12	27,5	5704979426346
PB 100122	3/4"	16,3	16,7	33,5	5704979426353
PB 100123	1"	19,1	19,9	42	5704979426360
PB 100124	1-1/4"	21,4	25,6	51	5704979426377
PB 100125	1-1/2"	21,4	35,6	62	5704979426384
PB 100126	2"	25,7	45,3	77	5704979426391
PB 100127	2-1/2"	30,2	52,8	89	5704979426407
PB 100128	3"	33,3	64,7	103	5704979426414
PB 100129	4"	39,3	78,7	129	5704979426421

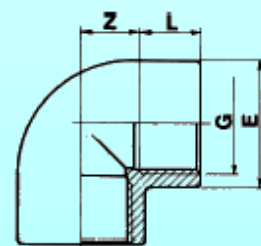

Best. nr.	G	L	Z	E	EAN/Barcode
Vinkel 45° / 16 bar 2 x indvendigt gevind					
PB 100141	1/2"	15	12	27,5	5704979426469
PB 100142	3/4"	16,3	16,7	33,5	5704979426476
PB 100143	1"	19,1	19,9	42	5704979426483
PB 100144	1-1/4"	21,4	25,6	51	5704979426490
PB 100145	1-1/2"	21,4	35,6	62	5704979426506
PB 100146	2"	25,7	45,3	77	5704979426513
PB 100147	2-1/2"	30,2	52,8	89	5704979426520
PB 100148	3"	33,3	64,7	106	5704979426537
PB 100149	4"	39,3	78,7	129	5704979426544

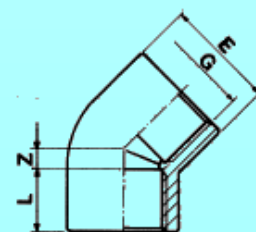

Best. nr.	D x G	L1	L2	Z1	Z2	E	EAN/Barcode
Vinkel 90° / 16 bar lim x indvendigt gevind							
PB 010220	16 X 3/8"	14	11,4	9	11,6	23	5704979426582
PB 010221	20 X 1/2"	16	15	11	12	28	5704979426599
PB 010222	25 X 3/4"	19	16,3	14	16,7	34	5704979426605
PB 010223	32 X 1"	22	19,1	17	19,9	42	5704979426612
PB 010224	40 X 1-1/4"	26	21,4	21	25,6	51	5704979426629
PB 010225	50 X 1-1/2"	31	21,4	26	35,6	61	5704979426636
PB 010226	63 X 2"	38	25,7	33	45,3	75	5704979426643
PB 010227	75 X 2-1/2"	44	30,2	39	52,8	89	5704979426650
PB 010228	90 X 3"	51	33,3	47	64,7	106	5704979426667
PB 010229	110 X 4"	61	39,3	57	78,7	129	5704979426674

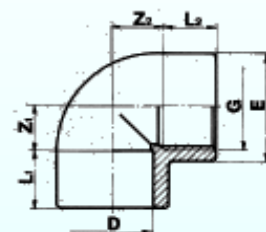

Best. nr.	D x G	L1	L2	Z1	Z2	E	EAN/Barcode
Vinkel 90° / 16 bar lim x indvendigt gevind Gevindforstærkning i rustfrit stål							
PB 010300	16 X 3/8"	14	11,4	9	11,6	23	5704979426711
PB 010301	20 X 1/2"	16	15	11	12	28	5704979426728
PB 010302	25 X 3/4"	19	16,3	14	16,7	34	5704979426735
PB 010303	32 X 1"	22	19,1	17	19,9	42	5704979426742
PB 010304	40 X 1-1/4"	26	21,4	21	25,6	51	5704979426759
PB 010305	50 X 1-1/2"	31	21,4	26	35,6	61	5704979426766
PB 010306	63 X 2"	38	25,7	33	45,3	75	5704979426773

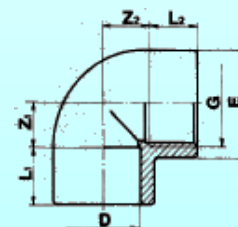

Best. nr.	d1 x d2	Z1	B	C	EAN/Barcode
Vinkel 90° / 10 bar lim x udvendigt gevind					
PB 010200	32 X 3/4"	21	22	19	5704979426810
PB 010201	32 X 1"	21	22	19	5704979426827
PB 010202	32 X 1-1/4"	17	22	21	5704979426834
PB 010203	40 X 1-1/4"	22	26	21	5704979426841
PB 010204	40 X 1-1/2"	22	26	21	5704979426858
PB 010205	50 X 1-1/4"	28	31	21	5704979426865
PB 010206	50 x 1-1/2"	28	31	21	5704979426872
PB 010207	50 x 2"	28	31	26	5704979426889

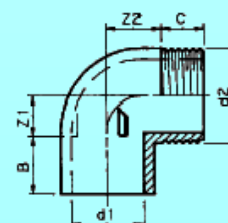

Best. nr.	d1 x d2	B	C	EAN/Barcode
T-stykke 10 bar lim x udv.-gev. x lim				
PB 020170	32 x 1-1/4"	22	19	5704979426926
PB 020171	40 x 1-1/4"	26	21	5704979426933
PB 020172	50 x 1-1/4"	31	21	5704979426940
PB 020173	50 x 1-1/2"	31	21	5704979426957
PB 020174	63 x 1"	38	19	5704979426964

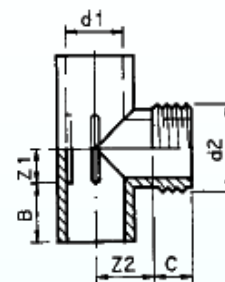

Best. nr.	D x G x D	L1	L2	Z1	Z2	E	EAN/Barcode
T-stykke 90° / 16 bar lim/gev./lim							
PB 020200	16 X 3/8" x 16	14	11,4	9	11,6	23	5704979427008
PB 020201	20 X 1/2" x 20	16	15	11	12	28	5704979427015
PB 020202	25 X 3/4" x 25	19	16,3	14	16,7	34	5704979427022
PB 020203	32 X 1" x 32	22	19,1	17	19,9	42	5704979427039
PB 020204	40 X 1-1/4" x 40	26	21,4	21	25,6	51	5704979427046
PB 020205	50 X 1-1/2" x 50	31	21,4	26	35,6	61	5704979427053
PB 020206	63 X 2" x 63	38	25,7	33	45,3	75	5704979427060
PB 020207	75 X 2-1/2" x 75	44	30,2	39	52,8	89	5704979427077
PB 020208	90 X 3" x 90	51	33,3	47	64,7	106	5704979427084
PB 020209	110 X 4" x 110	61	39,3	57	78,7	129	5704979427091

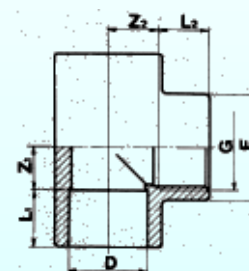

Best. nr.	D x G	L1	L2	Z1	Z2	E	EAN/Barcode
T-stykke 16 bar limmuffe x gevind <small>Gevindforstærkning i rustfrit stål</small>							
PB 020320	16 x 3/8"	14	11,4	9	11,6	23	5704979427138
PB 020321	20 x 1/2"	16	15	11	12	28	5704979427145
PB 020322	25 x 3/4"	19	16,3	14	16,7	34	5704979427152
PB 020323	32 x 1"	22	19,1	7	19,9	42	5704979427169
PB 020324	40 x 1-1/4"	26	21,4	21	25,6	51	5704979427176
PB 020325	50 x 1-1/2"	31	21,4	26	25,6	61	5704979427183
PB 020326	63 x 2"	38	25,7	33	45,3	75	5704979427190

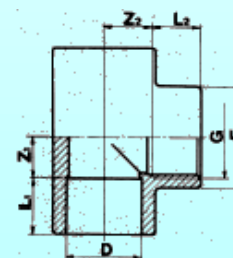

Best. nr.	G	L	H	E	EAN/Barcode
T-stykke 90° / 16 bar 3 x indiv.-gev.					
PB 120220	3/8"	11,4	11,6	23,5	5704979427237
PB 120221	1/2"	15	12	27,5	5704979427244
PB 120222	3/4"	16,3	16,7	33,5	5704979427251
PB 120223	1"	19,1	19,9	42	5704979427268
PB 120224	1-1/4"	21,4	25,6	51	5704979427275
PB 120225	1-1/2"	21,4	35,6	62	5704979427282
PB 120226	2"	25,7	45,3	77	5704979427299
PB 120227	2-1/2"	30,2	52,8	89	5704979427305
PB 120228	3"	33,3	64,7	103	5704979427312
PB 120229	4"	39,3	78,7	129	5704979427329

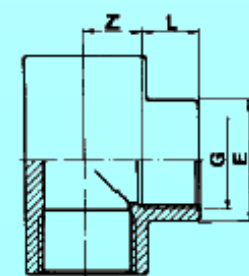
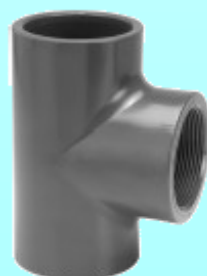

Længde: 5 m., transparent, DIN 8062 & ISO standard, er selvslukkende i henhold til DIN 4102, medium: vand.

Kan leveres tilskåret i alle mål - mod en tillægspris for skæring + spild i alt tillægges 30 %.

Levering: fra lager - bemærk at alle produkter mærket med en * 2 til 4 uger fra ordre.

Akryl rør 16 - 400 mm.: pris efter forespørgsel, levering: 2 til 4 uger fra ordre.

Best. Nr.	Størrelse (mm.)	PN	EAN/Barcode
PVC rør - transparent, hård			
*PF 070600	12 x 1,0	16	5704979330056
*PF 070602	12 x 1,4	20	5704979330063
*PF 070604	16 x 1,2	16	5704979330070
*PF 070606	20 x 1,5	16	5704979330087
PF 070608	25 x 1,5	10	5704979330094
*PF 070610	25 x 1,9	16	5704979330100
PF 070612	32 x 1,8	10	5704979330117
*PF 070614	32 x 2,4	16	5704979330124
*PF 070616	40 x 2,0	10	5704979330131
*PF 070618	40 x 3,0	16	5704979330148
PF 070620	50 x 1,8	6	5704979330155
*PF 070622	50 x 2,4	10	5704979330162
*PF 070624	50 x 3,7	16	5704979330179
PF 070626	63 x 1,8	4	5704979330186
*PF 070628	63 x 3,0	10	5704979330193
*PF 070630	63 x 4,7	16	5704979330209
*PF 070632	75 x 1,8	4	5704979330216
*PF 070634	75 x 3,6	10	5704979330223
*PF 070636	90 x 1,8	4	5704979330230
*PF 070638	90 x 4,3	10	5704979330247
PF 070640	110 x 2,2	4	5704979330254
*PF 070642	110 x 5,3	10	5704979330261
PF 070644	125 x 2,5	4	5704979330278
*PF 070646	140 x 2,8	4	5704979330285
*PF 070648	160 x 3,2	4	5704979330292
*PF 070650	160 x 4,7	6	5704979330308

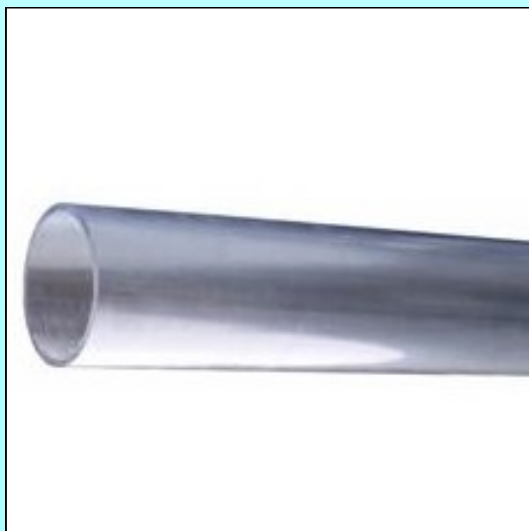
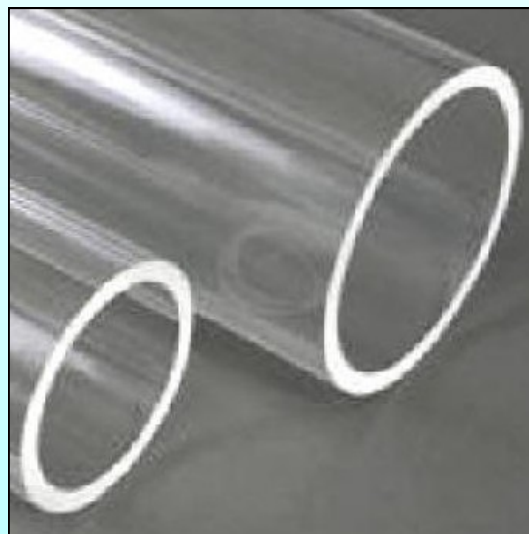
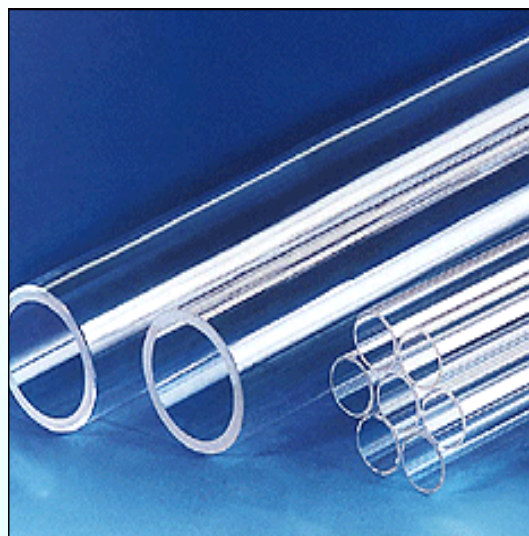

Best. nr.	Størrelse mm	Længde	Pakning	EAN/Barcode
Rør - 7,5 ATÜ med limmuffe				
PF 020490	25 x 1,5	500 cm	2.500 m.	5704979330346
PF 021402	32 x 1,6	500 cm	1.220 m.	5704979330353
PF 021422	40 x 1,9	500 cm	1.225 m.	5704979330360
PF 022404	50 x 2,0	500 cm	1.075 m.	5704979330377
PF 022405	63 x 2,0	500 cm	800 m.	5704979330384
PF 022406	75 x 2,2	500 cm	500 m.	5704979330391
PF 022407	90 x 2,7	500 cm	315 m.	5704979330407
PF 022408	110 x 3,2	500 cm	215 m.	5704979330414
PF 022409	125 x 3,7	500 cm	190 m.	5704979330421
PF 022410	160 x 4,7	500 cm	110 m.	5704979330438
PF 022411	200 x 5,9	500 cm	70 m.	5704979330445
PF 022413	250 x 7,3	500 cm	35 m.	5704979330452
PF 022414	315 x 9,2	500 cm	25 m.	5704979330469

Best. nr.	Størrelse	Længde cm.	EAN/Barcode
Rør PVC KIWA - 10 bar med limmuffe			
PF 030490	25 x 1,5	500	5704979330506
PF 031402	32 x 1,6	500	5704979330513
PF 031422	40 x 1,9	500	5704979330520
PF 031423	50 x 2,4	500	5704979330537
PF 031424	63 x 2,4	500	5704979330544
PF 031425	75 x 2,9	500	5704979330551
PF 031426	90 x 3,5	500	5704979330568
PF 031427	110 x 4,2	500	5704979330575
PF 031428	125 x 4,8	500	5704979330582
PF 031429	160 x 6,2	500	5704979330599
PF 031430	200 x 7,7	500	5704979330605

Best. nr.	Størrelse	Længde	Pakning	EAN/Barcode
Rør KIWA - 16 ATÜ uden limmuffe				
PF 050250	12 x 1,0 mm.	400 cm	-	5704979330643
PF 050251	16 x 1,5 mm.	400 cm	6.000 m.	5704979330650
PF 050252	20 x 1,5 mm.	400 cm	5.000 m.	5704979330667
PF 050253	25 x 1,9 mm.	400 cm	2.000 m.	5704979330674
PF 050254	32 x 2,4 mm.	400 cm	976 m.	5704979330681
PF 050255	40 x 3,0 mm.	400 cm	980 m.	5704979330698
PF 050256	50 x 3,7 mm.	400 cm	860 m.	5704979330704
PF 050257	63 x 3,8 mm.	400 cm	640 m.	5704979330711

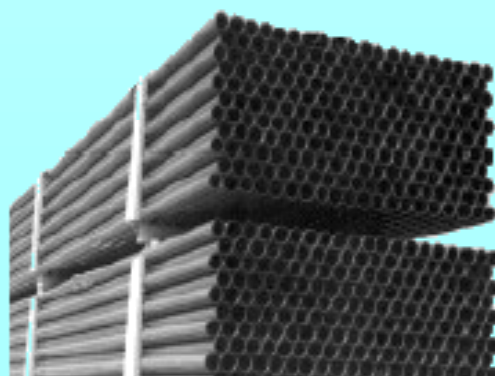
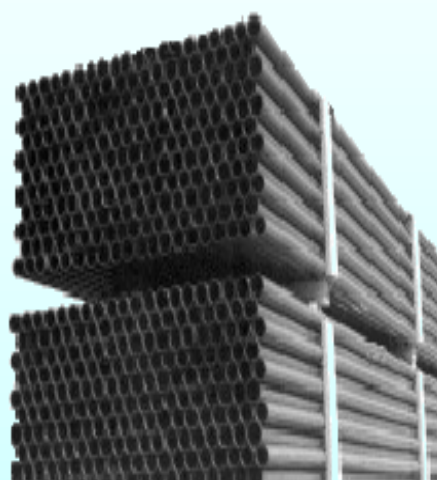

Best. nr.	D1	B	D2	EAN/Barcode
Omløbermøtrik 16 bar				
PB 150420	1/2"	13	38	5704979428067
PB 150421	3/4"	14	43	5704979428074
PB 150422	1"	16	56	5704979428081
PB 150423	1-1/4"	18	65	5704979428098
PB 150424	1-1/2"	19	72	5704979428104
PB 150425	2"	21	94	5704979428111
PB 150426	2-1/2"	23	105	5704979428128
PB 150427	3"	27	125	5704979428135
PB 150428	4"	31	153	5704979428142

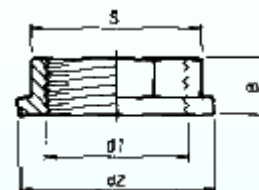

Best. nr.	D1	*Længde (mm.)	EAN/Barcode
Gevindrør 16 bar * Ekstra længder på bestilling			
PB 150460	1/2"	60	5704979428180
PB 150461	3/4"	60	5704979428197
PB 150462	1"	80	5704979428203
PB 150463	1-1/4"	80	5704979428210
PB 150464	1-1/2"	80	5704979428227
PB 150465	2"	100	5704979428234
PB 150466	2-1/2"	120	5704979428241
PB 150467	3"	150	5704979428258
PB 150468	4"	150	5704979428265



Best. nr.	D	EAN/Barcode	Best. nr.	D	EAN/Barcode
Rørholder type VDL					
PB 160228	10	5704979428319	PB 160238	90	5704979428418
PB 160229	12	5704979428326	PB 160239	110	5704979428425
PB 160230	16	5704979428333	PB 160240	125	5704979428432
PB 160231	20	5704979428340	PB 160241	140	5704979428449
PB 160232	25	5704979428357	PB 160242	160	5704979428456
PB 160233	32	5704979428364	PB 160243	200	5704979428463
PB 160234	40	5704979428371	PB 160244	225	5704979428470
PB 160235	50	5704979428388	PB 160245	250	5704979428487
PB 160236	63	5704979428395	PB 160246	315	5704979428494
PB 160237	75	5704979428401			



bis 32 mm



ab 40 mm

Best. nr.	D mm	EAN/Barcode	Best. nr.	D	EAN/Barcode
Underlag 20 mm. til VDL rørholder					
PB 160248	10/12	5704979428531	PB 160255	63	5704979428609
PB 160249	16	5704979428548	PB 160256	75	5704979428616
PB 160250	20	5704979428555	PB 160257	90	5704979428623
PB 160251	25	5704979428562	PB 160258	110	5704979428630
PB 160252	32	5704979428579	PB 160259	125	5704979428647
PB 160253	40	5704979428586	PB 160260	140	5704979428654
PB 160254	50	5704979428593	PB 160261	160	5704979428661



Træskrue med gevindtap, skal monteres i fastgørelsesknaster eller montageøskner.

Best. nr.	Type	EAN/Barcode
Træbolt		
PT 010160	M6 x 60	5704979441264
PT 010162	M6 x 90	5704979441271
PT 010164	M6 x 150	5704979441288
PT 010166	M8 x 90	5704979441295
PT 010168	M8 x 120	5704979441301
PT 010170	M8 x 150	5704979441318



Gevindbøsning til forlængelse af gevindstænger.

Best. nr.	Type	EAN/Barcode
Koblingsstykke		
PT 010200	M6 x 25	5704979441479
PT 010202	M8 x 30	5704979441486



Best. nr.	Type	EAN/Barcode
Gevindstang		
PT 010220	M6 x 1 m.	5704979441523
PT 010222	M8 x 1 m.	5704979441530
PT 010224	M10 x 1 m.	5704979441547



Fremstillet i stål for fastgørelse af kanalisationsrør.

Termisk galvaniseret.

*Bøjle dia.: 250/315 mm. anvendes med enkelt møtrik.

Best. nr.	Type	EAN/Barcode
Rørbærer - termisk galvaniseret		
PT 010230	32 x M8	5704979441585
PT 010232	40 x M8	5704979441592
PT 010234	50 x M8	5704979441608
PT 010236	63 x M8	5704979441615
PT 010238	75 x M8	5704979441622
PT 010240	90 x M8	5704979441639
PT 010242	110 x M8	5704979441646
PT 010244	125 x M8	5704979441653
PT 010246	160 x M8	5704979441660
PT 010248	200 x M8	5704979441677
PT 010250	*250 x M8	5704979441684
PT 010252	*315 x M8	5704979441691

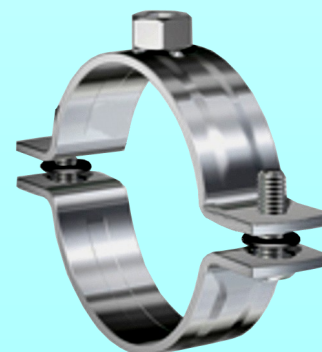

FERNCO fleksible rørkoblinger

FERNCO kobling er en fleksibel forbindelse, fremstillet i PVC elastomer, som holdes i position af to spændeområde i rustfrit stål.

PVC elastomer har meget stor træk - og rivestyrke, er meget fleksibel og ikke underlagt ældning. Den er modstandsdygtig overfor UV-stråler, rodvækst, kanalisationsgas, bakterier, kemikalier m.m.

Ledninger af forskellige mål og/eller materialer, kan forbindes uden problemer.

FERNCO koblinger leveres i mange forskellige mål (32 - 685 mm.). Koblingerne kan anbringes på alle rørtyper: PVC, PE, PP, stål, støbejern, bly, kobber, aluminium, beton, stentøj, asbestcement m.m..

Selv om den nøjagtige dimension er ukendt, kan FERNCO koblinger anvendes.

FERNCO koblinger har en enorm fleksibilitet og kan endda monteres på rør, hvis udvendige diameter er betydeligt mindre end de mål, til hvilke koblingen er designet. En forskel på 20 mm. kan klares.

FERNCO koblinger er egnet til alle samlinger, i forbindelse med afløbsrør, f. eks.: kanal-, sanitær- og regnvands afløb, samt reparationer, tilkoblinger m.m.. I princippet, kan koblingerne anvendes i alle ledninger uden tryk eller med lavt tryk.

Leveringstid for andre mål: 1 uge fra ordre.		
Best. nr.	Spændeområde	EAN/Barcode
Kobling - lige		
PU 010100	38 - 41 mm.	5704979428708
PU 010102	50 - 63 mm.	5704979428715
PU 010103	65 - 70 mm.	5704979428722
PU 010105	90 - 101 mm.	5704979428739
PU 010106	98 - 115 mm.	5704979428746
PU 010108	120 - 136 mm.	5704979428753
PU 010110	145 - 168 mm.	5704979428760
PU 010114	199 - 219 mm.	5704979428777



Best. nr.	Størrelse	Spændeområde	EAN/Barcode
Fleksibel muffe - lige			
PU 010119	1¼"/40mm.	38 - 41 mm.	5704979428883
PU 010120	1½"/50mm.	44 - 50 mm.	5704979428890
PU 010122	2"/63mm.	57 - 63 mm.	5704979428906
PU 010126	3"/90mm.	82 - 90 mm.	5704979428913
PU 010128	4"/110mm.	100 - 110 mm.	5704979428920



Leveringstid for andre mål: 2 uger fra ordre.		
Slutmuffer og rørtilslutningssadel kan også levers på bestilling.		
Best. nr.	Spænde-område	EAN/Barcode
Kobling - reduceret		
PU 010132	75/88 - 50/63	5704979428807
PU 010135	120/133 - 98/115	5704979428814
PU 010138	145/168 - 98/115	5704979428821



Best. nr.	Størrelse	EAN/Barcode
Fleksibel reduceringsmuffe		
PU 010140	1½" x 1¼" / 50 x 40mm.	5704979428982
PU 010142	2" x 1½" / 63 x 50mm.	5704979428999
PU 010146	3" x 2" / 90 x 63mm.	5704979429002
PU 010148	4" x 3" / 110 x 90mm.	5704979429026



Best. nr.	Størrelse	Spændeområde	EAN/Barcode
Fleksibelt T-stykke			
PU 010150	1½"/50mm.	50 - 44 mm.	5704979429262
PU 010152	2"/63mm.	63 - 57 mm.	5704979429279
PU 010156	3"/90mm.	90 - 82 mm.	5704979429286
PU 010158	4"/110mm.	110 - 100 mm.	5704979429293



Best. nr.	Størrelse	Spændeområde	EAN/Barcode
Fleksible endekapper			
PU 010160	1½"/ 50mm.	50 - 44 mm.	5704979429088
PU 010162	2"/ 63mm.	63 - 57 mm.	5704979429095
PU 010166	3"/ 90mm.	90 - 82 mm.	5704979429101
PU 010168	4"/110mm.	110 - 100 mm.	5704979429118



Best. nr.	Størrelse	Spændeområde	EAN/Barcode
Fleksibel bøjning			
PU 010170	1½"/50mm.	50 - 44 mm.	5704979429170
PU 010172	2"/63mm.	63 - 57 mm.	5704979429187
PU 010176	3"/90mm.	90 - 82 mm.	5704979429194
PU 010178	4"/110mm.	110 - 100 mm.	5704979429200



EKSEMPEL

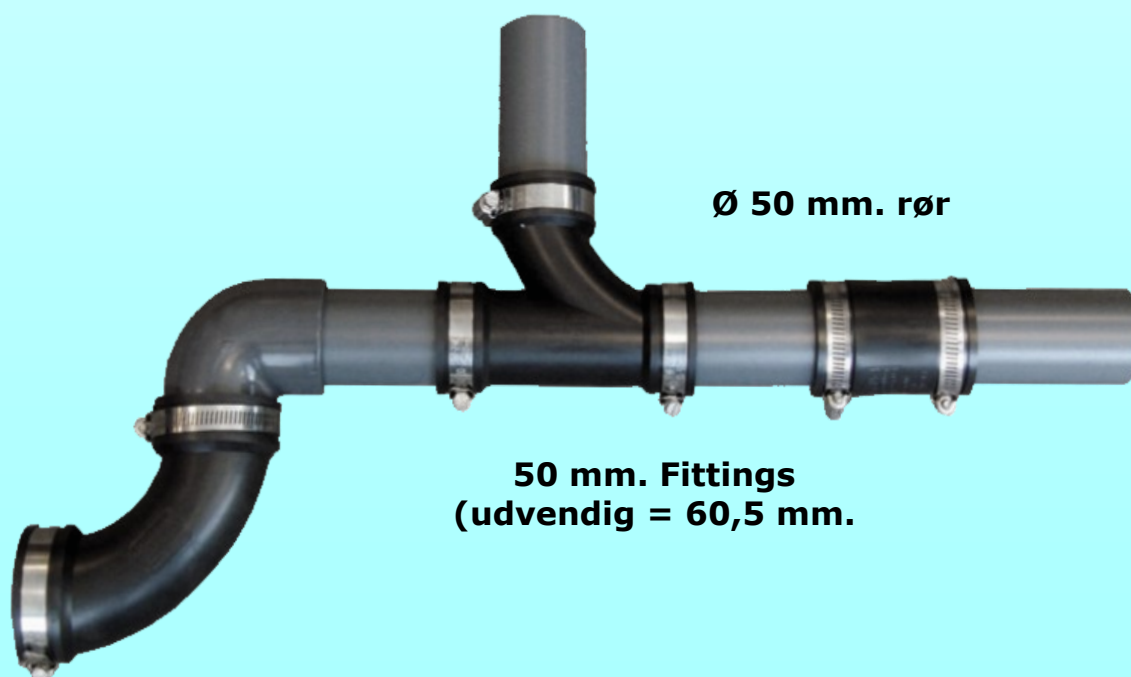

Ø 50 mm. rør

50 mm. Fittings
(udvendig = 60,5 mm.)

Best. Nr.	Mål						EAN/Barcode
Adapter Flex-Fit / Klem x Lim							
	d - d1	L	e	L1	L2	E1	
GL 407005	50 × 50	103,5	58	31,5	69	89	5704979430091
GL 407010	50 × 11/2"	103,5	58	31,5	69	89	5704979430107
GL 407015	63 × 63	120,5	71,6	38,5	79	108	5704979430114
GL 407020	63 × 2"	120,5	71,6	38,5	79	108	5704979430121

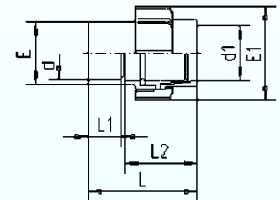

Best. Nr.	Mål						EAN/Barcode
Adapter Flex-Fit BSP / Klem x Indvendig gevind							
	d	L	e	L1	L2	E1	
GL 407055	50 × 11/2"	103,5	58	31,5	69	89	5704979430176
GL 407060	63 × 2"	120,5	72	27,5	79	108	5704979430183

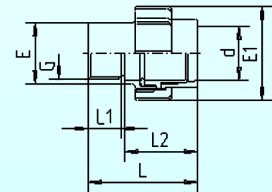

Best. Nr.	Mål				EAN/Barcode
Adapter Flex-Fit / Klem x Klem					
	d - d1	L	E	L1	
GL 407205	50 × 50	97	56	69	5704979430237
GL 407210	50 × 11/2"	97	56	69	5704979430244
GL 407215	63 × 63	119	72	79	5704979430251
GL 407220	63 × 2"	119	72	79	5704979430268

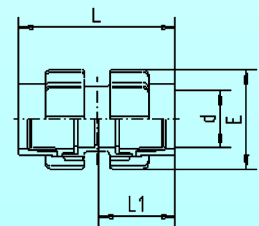

Best. Nr.	Mål								EAN/Barcode
Adapter Flex-Fit / Klem - udvendig gevind x O-ring									
	d	d1	L	e	L1	L2	Z	Z1	
GL 407105	50 × 11/2"	39	90,8	89	18	69	48	58	5704979430336
GL 407110	50 × 2"	49	189,4	108	23	69	60	69	5704979430343
GL 407115	63 × 2"	49	109,4	89	23	79	60	69	5704979430350

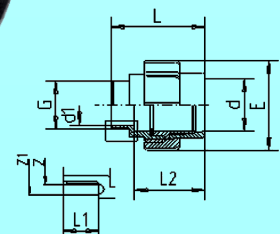

Best. Nr.	Mål				EAN/Barcode
Adapter vinkel Flex-Fit 90° / Klem x Lim					
	d1 – d2	Z	D	E	
GL 407505	140 - 11/4"	80	6	6	5704979430428
GL 407510	140 - 2"	80	6	6	5704979430435
GL 407515	140 - 21/2"	80	6	6	5704979430442
GL 407520	160 - 1"	90	6	6	5704979430459
GL 407525	160 - 11/4"	90	6	6	5704979430466
GL 407530	160 - 11/2"	90	6	6	5704979430473
GL 407535	160 - 2"	90	6	6	5704979430480
GL 407540	160 - 21/2"	94	6	6	5704979430497
GL 407545	160 - 3"	94	6	6	5704979430503

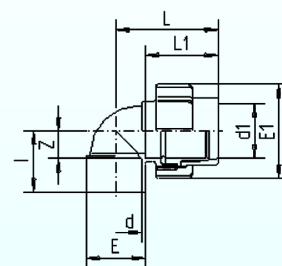

Best. Nr.	Mål							EAN/Barcode
Adapter vinkel Flex-Fit 90° BSP / Klem x Indvendig gevind								
	d – G	I	L	E	L1	E1	Z	
GL 407605	50 × 11/2" IG	57,5	97	56	69	89	26	5704979430589
GL 407610	63 × 2" IG	71	119	72	79	108	32,5	5704979430596

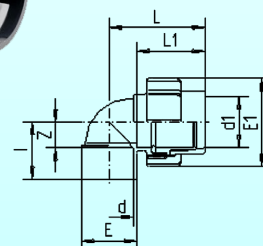

Best. Nr.	Mål							EAN/Barcode
Adapter vinkel Flex-Fit 90° BSP / Klem x Udvendig gevind								
	d – G	d1	L	E	L1	L2	L3	
GL 407705	50 × 11/2"	36	94,5	89	85	63	69	5704979430671
GL 407710	63 × 2"	48	119	108	85	56,3	79	5704979430688

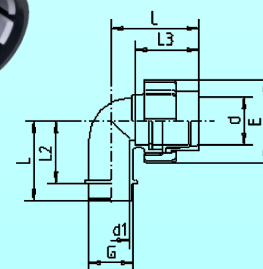

Best. Nr.	Type	Størrelse	EAN/Barcode
Monteringsnøgler			
GL 408050	Værktøj	Til 50 mm	5704979430008
GL 408063	Værktøj	Til 63 mm	5704979430015

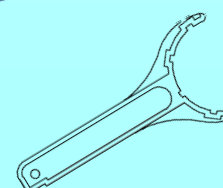



SPA Flexslanger

SPX Flexslanger



Alle SPA Flexslangerne passer perfekt sammen med det store program i FLEXFIT fittings.

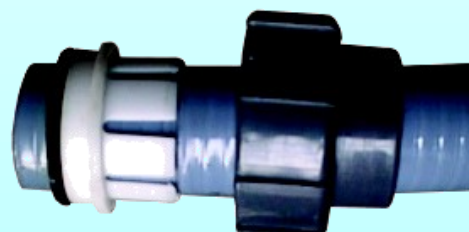

Best. Nr.	Type	Dia./ Ø.	Mål	Længde	Materiale	Farve	EAN/Barcode
GL 330020	SPA Flexslange	20 mm.	Udvendig	25 m.	PVC	Grå / Hvid	5704979310003
GL 330025	SPA Flexslange	25 mm.	Udvendig	25 m.	PVC	Grå / Hvid	5704979310010
GL 330032	SPA Flexslange	32 mm.	Udvendig	25 m.	PVC	Grå / Hvid	5704979310027
GL 330040	SPA Flexslange	40 mm.	Udvendig	25 m.	PVC	Grå / Hvid	5704979310034
GL 330050	SPA Flexslange	50 mm.	Udvendig	25 m.	PVC	Grå / Hvid	5704979310041
GL 330063	SPA Flexslange	63 mm.	Udvendig	25 m.	PVC	Grå / Hvid	5704979310058
GL 330075	SPA Flexslange	75 mm.	Udvendig	25 m.	PVC	Grå / Hvid	5704979310065
GK 250038	SPX Flexslange	38 mm.	Indvendig	25 m.	PVC	Sort	5704979310089
GK 250040	SPX Flexslange	40 mm.	Indvendig	25 m.	PVC	Sort	5704979310096
GK 250050	SPX Flexslange	50 mm.	Indvendig	25 m.	PVC	Sort	5704979310102

OBS: alle SPA Flexslangerne kan limes direkte i PVC fittings med f.eks. Tangit

Kugleventil med overgang til PE spændkobling
 - O-ring: EPDM
 - Kugleindsats: PTFE (Teflon)
 - Arbejdsstryk: maks. 16 bar ved 20° C.

Best. nr.	Størrelse i mm.	EAN/Barcode
Kuglehane lim & spændkobling		
PD 020210	20 lim x 20 spænd	5704979415982
PD 020211	25 lim x 25 spænd	5704979415999
PD 020212	32 lim x 32 spænd	5704979416002



Best. nr.	d2/d3 x d1 PVC PE	EAN/Barcode
Overgang 10 bar - lige, PVC - PE		
PA 131340	25/32 x 16	5704979416040
PA 131341	25/32 x 20	5704979416057
PA 131342	25/32 x 25	5704979416064
PA 131343	32/40 x 32	5704979416071
PA 131344	40/50 x 40	5704979416088

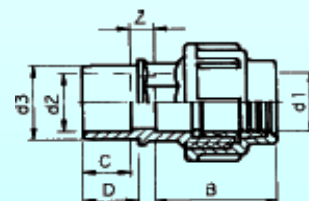

Best. nr.	d2 x d1 PVC PE	EAN/Barcode
Overgangsvinkel 10 bar PVC/PE		
PA 131350	32 x 16	5704979416125
PA 131351	32 x 20	5704979416132
PA 131352	32 x 25	5704979416149

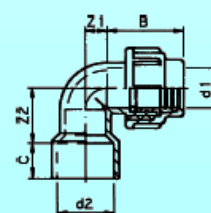

Best. nr.	d2 x d1 PVC PE	EAN/Barcode
Overgangs T-stk. 7,5 bar PE/PVC/PE		
PA 131358	32 x 20	5704979416187
PA 131359	32 x 25	5704979416194

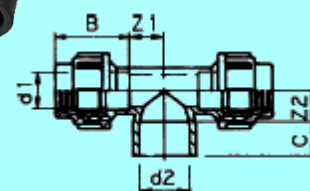

EFFAST SPÆNDEKOBLING TIL PE RØR

Kabinet i sort, møtrik i blå eller grøn, begge i polypropylen. O-ringe se side 51. Koblinger fra 2" er forsynet med forstærkningsring i rustfrit stål. Arbejdstryk (til 63 mm.): maks. 16 bar ved 20° C., arbejdstryk (fra 63 mm.): maks. 10 bar ved 20° C.

Best. nr.	Størrelse	EAN/Barcode
Kobling PE - lige TYPE 310		
PP 001700	16 x 16	5704979416231
PP 001710	20 x 20	5704979416248
PP 001720	25 x 25	5704979416255
PP 001730	32 x 32	5704979416262
PP 001740	40 x 40	5704979416279
PP 001750	50 x 50	5704979416286
PP 001760	63 x 63	5704979416293
PP 001770	75 x 75	5704979416309
PP 001780	90 x 90	5704979416316
PP 001790	110 x 110	5704979416323

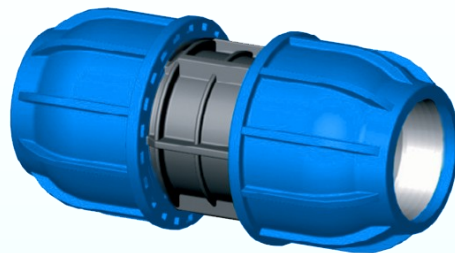

Best. nr.	Størrelse	VPE	VPE	EAN/Barcode
Kobling reduceret TYPE 311				
PP 011800	20 x 16	20	180	5704979416361
PP 011810	25 x 20	20	180	5704979416378
PP 011811	32 x 20	10	140	5704979416385
PP 011820	32 x 25	10	120	5704979416392
PP 011840	40 x 32	10	70	5704979416408
PP 011860	50 x 40	5	48	5704979416415
PP 011861	63 x 32	1	40	5704979416422
PP 011862	63 x 40	1	35	5704979416439
PP 011870	63 x 50	1	35	5704979416446
PP 011880	75 x 63	1	15	5704979416453
PP 011900	90 x 75	1	12	5704979416460
PP 011910	110 x 90	1	6	5704979416477

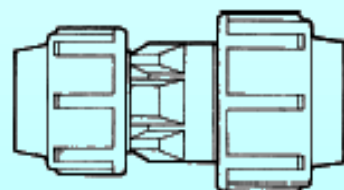

Best. nr.	Størrelse	VPE	VPE	EAN/Barcode
Slutmuffe TYPE 312				
PP 000800	16	20	700	5704979416514
PP 000810	20	20	500	5704979416521
PP 000820	25	20	300	5704979416538
PP 000830	32	20	180	5704979416545
PP 000840	40	10	100	5704979416552
PP 000850	50	10	60	5704979416569
PP 000860	63	1	45	5704979416576
PP 000870	75	1	25	5704979416583
PP 000880	90	1	16	5704979416590
PP 000890	110	1	8	5704979416606

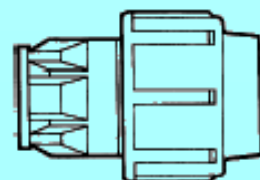
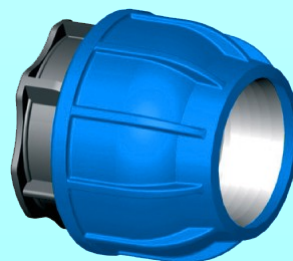

Best. nr.	Størrelse	EAN/Barcode
Kobling med indvendigt gevind TYPE 330		
PP 011400	16 x 1/2"	5704979416644
PP 011420	20 x 1/2"	5704979416651
PP 011430	20 x 3/4"	5704979416668
PP 011450	25 x 3/4"	5704979416675
PP 011460	25 x 1"	5704979416682
PP 011470	32 x 3/4"	5704979416699
PP 011480	32 x 1"	5704979416705
PP 011500	40 x 1"	5704979416712
PP 011510	40 x 1-1/4"	5704979416729
PP 011511	40 x 1-1/2"	5704979416736
PP 011512	50 x 1-1/2"	5704979416743
PP 011513	50 x 2"	5704979416750
PP 011514	63 x 2"	5704979416767
PP 011515	75 x 2"	5704979416774
PP 011516	75 x 2-1/2"	5704979416781
PP 011517	90 x 3"	5704979416798
PP 011518	110 x 4"	5704979416804

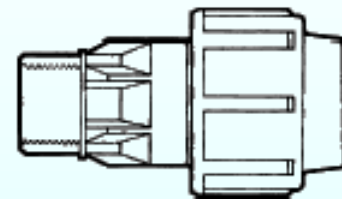

Best. nr.	Størrelse	EAN/Barcode
Kobling med udvendigt gevind TYPE 330		
PP 051000	16 x 1/2"	5704979416842
PP 051010	16 x 3/4"	5704979416859
PP 051020	20 x 1/2"	5704979416866
PP 051030	20 x 3/4"	5704979416873
PP 051040	25 x 1/2"	5704979416880
PP 051050	25 x 3/4"	5704979416897
PP 051060	25 x 1"	5704979416903
PP 051070	32 x 3/4"	5704979416910
PP 051080	32 x 1"	5704979416927
PP 051090	32 x 1-1/4"	5704979416934
PP 051100	40 x 1"	5704979416941
PP 051110	40 x 1-1/4"	5704979416958
PP 051120	40 x 1-1/2"	5704979416965
PP 051140	50 x 1-1/2"	5704979416972
PP 051150	50 x 2"	5704979416989
PP 051160	63 x 1-1/2"	5704979416996
PP 051170	63 x 2"	5704979417009
PP 051180	63 x 2-1/2"	5704979417016
PP 051190	75 x 2"	5704979417023
PP 051200	75 x 2-1/2"	5704979417030
PP 051210	75 x 3"	5704979417047
PP 051230	90 x 3"	5704979417054
PP 051240	90 x 4"	5704979417061
PP 051250	110 x 3"	5704979417078
PP 051260	110 x 4"	5704979417085

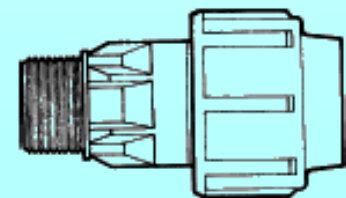
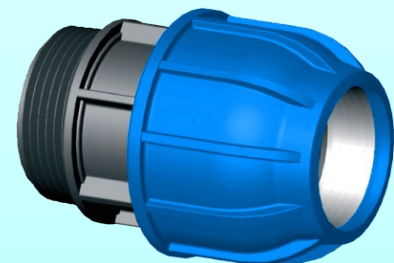

Best. nr.	Størrelse	EAN/Barcode
T-styk 90° TYPE 340		
PP 062000	16 x 16 x 16	5704979417122
PP 062010	20 x 20 x 20	5704979417139
PP 062020	25 x 25 x 25	5704979417146
PP 062030	32 x 32 x 32	5704979417153
PP 062040	40 x 40 x 40	5704979417160
PP 062050	50 x 50 x 50	5704979417177
PP 062060	63 x 63 x 63	5704979417184
PP 062070	75 x 75 x 75	5704979417191
PP 062080	90 x 90 x 90	5704979417207
PP 062090	110 x 110 x 110	5704979417214

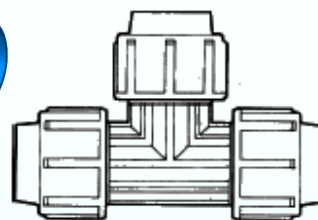
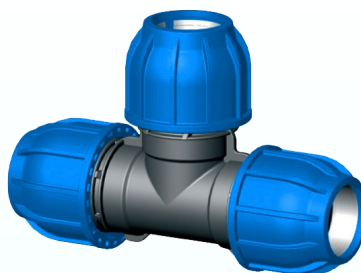

Best. nr.	Størrelse	EAN/Barcode
T-styk 90° - reduceret TYPE 343		
PP 072160	25 x 20 x 25	5704979417252
PP 072170	32 x 25 x 32	5704979417269
PP 072180	40 x 32 x 40	5704979417276
PP 072190	50 x 32 x 50	5704979417283
PP 072200	50 x 40 x 50	5704979417290
PP 072210	63 x 50 x 63	5704979417306

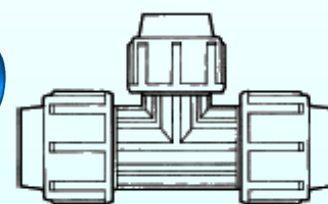
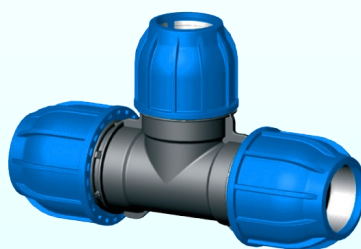

Best. nr.	Størrelse	EAN/Barcode
T-styk 90° - udvendigt gevind TYPE 341		
PP 083100	16 x 1/2" x 16	5704979417344
PP 083110	16 x 3/4" x 16	5704979417351
PP 083120	20 x 1/2" x 20	5704979417368
PP 083130	20 x 3/4" x 20	5704979417375
PP 083140	25 x 3/4" x 25	5704979417382
PP 083150	25 x 1" x 25	5704979417399
PP 093090	32 x 3/4" x 32	5704979417405
PP 093160	32 x 1" x 32	5704979417412
PP 093180	40 x 1-1/2" x 40	5704979417429
PP 093190	50 x 1-1/2" x 50	5704979417436
PP 093200	63 x 2" x 63	5704979417443
PP 093210	75 x 2-1/2" x 75	5704979417450
PP 093220	90 x 3" x 90	5704979417467
PP 093230	110 x 4" x 110	5704979417474

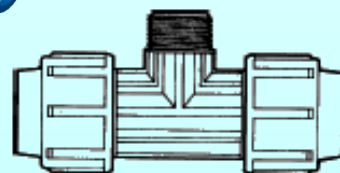
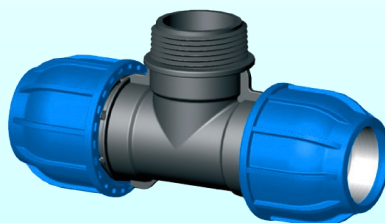

Best. nr.	Størrelse	EAN/Barcode
T-styk 90° - indvendigt gevind TYPE 342		
PP 102400	16 x 1/2" x 16	5704979417528
PP 112340	16 x 3/4" x 16	5704979417535
PP 112420	20 x 1/2" x 20	5704979417542
PP 112430	20 x 3/4" x 20	5704979417559
PP 112440	25 x 1/2" x 25	5704979417566
PP 112450	25 x 3/4" x 25	5704979417573
PP 112460	25 x 1" x 25	5704979417580
PP 112480	32 x 3/4" x 32	5704979417597
PP 112490	32 x 1" x 32	5704979417603
PP 112510	40 x 1" x 40	5704979417610
PP 112520	40 x 1-1/4" x 40	5704979417627
PP 122350	40 x 1-1/2" x 40	5704979417634
PP 122530	50 x 1-1/2" x 50	5704979417641
PP 122540	63 x 2" x 63	5704979417658
PP 122550	75 x 2-1/2" x 75	5704979417665
PP 122560	90 x 3" x 90	5704979417672
PP 132390	90 x 4" x 90	5704979417689
PP 132580	110 x 3" x 110	5704979417696
PP 132570	110 x 4" x 110	5704979417702

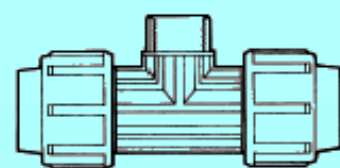
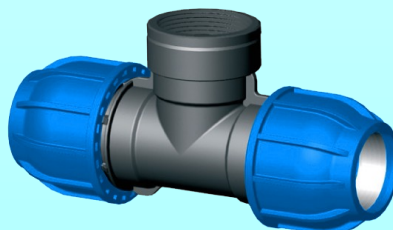

Best. nr.	Størrelse	EAN/Barcode
Vinkel 90° TYPE 350		
PP 142900	16 x 16	5704979417733
PP 142910	20 x 20	5704979417740
PP 142920	25 x 25	5704979417757
PP 142930	32 x 32	5704979417764
PP 142940	40 x 40	5704979417771
PP 142950	50 x 50	5704979417788
PP 142960	63 x 63	5704979417795
PP 142970	75 x 75	5704979417801
PP 142980	90 x 90	5704979417818
PP 142990	110 x 110	5704979417825

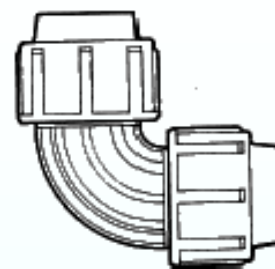

Best. nr.	Størrelse	EAN/Barcode
Vinkel 90° - udvendigt gevind TYPE 351		
PP 153300	16 x 1/2"	5704979417863
PP 153310	20 x 1/2"	5704979417870
PP 163260	20 x 3/4"	5704979417887
PP 173250	25 x 1/2"	5704979417894
PP 173320	25 x 3/4"	5704979417900
PP 173330	25 x 1"	5704979417917
PP 183270	32 x 3/4"	5704979417924
PP 183340	32 x 1"	5704979417931
PP 193240	40 x 1"	5704979417948
PP 193350	40 x 1-1/4"	5704979417955
PP 193360	50 x 1-1/2"	5704979417962
PP 203290	50 x 2"	5704979417979
PP 203370	63 x 2"	5704979417986
PP 203390	75 x 2-1/2"	5704979417993
PP 203410	90 x 3"	5704979418006
PP 203420	110 x 4"	5704979418013

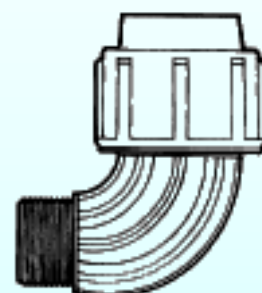
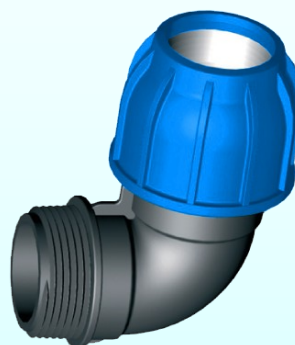

Best. nr.	Størrelse	EAN/Barcode
Vinkel 90° - indvendigt gevind TYPE 352		
PP 212600	16 x 1/2"	5704979418051
PP 212620	20 x 1/2"	5704979418068
PP 212630	20 x 3/4"	5704979418075
PP 212650	25 x 3/4"	5704979418082
PP 212660	25 x 1"	5704979418099
PP 212680	32 x 3/4"	5704979418105
PP 212690	32 x 1"	5704979418112
PP 212710	40 x 1-1/4"	5704979418129
PP 212730	50 x 1-1/2"	5704979418136
PP 212750	63 x 2"	5704979418143
PP 212790	75 x 2"	5704979418150
PP 212791	75 x 2-1/2"	5704979418167
PP 212792	90 x 3"	5704979418174
PP 212793	110 x 4"	5704979418181

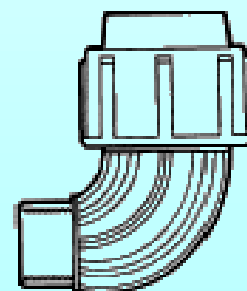

Best. nr.	Størrelse	EAN/Barcode
O-ring		
PP 220700	16	5704979441738
PP 220710	20	5704979441745
PP 220720	25	5704979441752
PP 220730	32	5704979441769
PP 220740	40	5704979441776
PP 220750	50	5704979441783
PP 220760	63	5704979441790
PP 220770	75	5704979441806
PP 220780	90	5704979441813
PP 220790	110	5704979441820

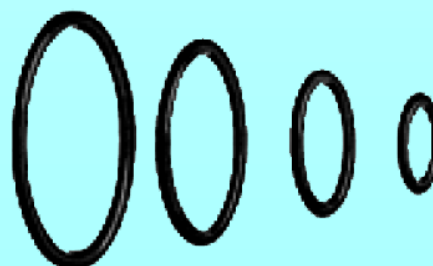

Best. nr.	Størrelse	PN	Rulle	EAN/Barcode
Rør PE 40 - PN6 til vandrør med KIWA prøvecertifikat				
PX 020150	16 x 1,8	6	50 m.	5704979340031
PX 020151	16 x 1,8	6	100 m.	5704979340048
PX 020152	20 x 2,2	6	50 m.	5704979340055
PX 020153	20 x 2,2	6	100 m.	5704979340062
PX 020154	25 x 2,7	6	50 m.	5704979340079
PX 020155	25 x 2,7	6	100 m.	5704979340086
PX 020156	32 x 3,5	6	50 m.	5704979340093
PX 020157	32 x 3,5	6	100 m.	5704979340109
PX 020158	40 x 4,3	6	50 m.	5704979340116
PX 020159	40 x 4,3	6	100 m.	5704979340123
PX 020160	50 x 5,4	6	50 m.	5704979340130
PX 020161	50 x 5,4	6	100 m.	5704979340147
PX 020162	63 x 6,8	6	50 m.	5704979340154
PX 020163	63 x 6,8	6	100 m.	5704979340161



Best. nr.	Størrelse	PN	Rulle	EAN/Barcode
Rør PE 80 - PN8 m. KIWA/GASTEC Til vand/gas med prøvecertifikat				
PX 020171	32 x 2,0	8	100 m.	5704979340208
PX 020172	40 x 2,3	8	100 m.	5704979340215
PX 020173	50 x 2,9	8	100 m.	5704979340222
PX 020174	63 x 3,6	8	100 m.	5704979340239
PX 020175	75 x 4,3	8	50 m.	5704979340246
PX 020176	75 x 4,3	8	100 m.	5704979340253
PX 020177	90 x 5,1	8	50 m.	5704979340260
PX 020178	90 x 5,1	8	100 m.	5704979340277
PX 020179	110 x 6,3	8	50 m.	5704979340284
PX 020180	110 x 6,3	8	100 m.	5704979340291



Best. Nr.	Størrelse	PN	Rulle	EAN/Barcode
Rør PE 80 BUIS - PN 12,5 Med KIWA/GASTEC prøvecertifikat til vand/gas				
PX 020200	20 x 2,0	12,5	50 m.	5704979340338
PX 020202	20 x 2,0	12,5	100 m.	5704979340345
PX 020204	25 x 2,3	12,5	50 m.	5704979340352
PX 020206	25 x 2,3	12,5	100 m.	5704979340369
PX 020208	32 x 3,0	12,5	50 m.	5704979340376
PX 020210	32 x 3,0	12,5	100 m.	5704979340383
PX 020212	40 x 3,7	12,5	50 m.	5704979340390
PX 020214	40 x 3,7	12,5	100 m.	5704979340406
PX 020216	50 x 4,6	12,5	50 m.	5704979340413
PX 020218	50 x 4,6	12,5	100 m.	5704979340420
PX 020220	63 x 5,8	12,5	50 m.	5704979340437
PX 020222	63 x 5,8	12,5	100 m.	5704979340444
PX 020224	75 x 6,9	12,5	50 m.	5704979340451
PX 020226	75 x 6,9	12,5	100 m.	5704979340468
PX 020228	90 x 8,2	12,5	50 m.	5704979340475
PX 020230	90 x 8,2	12,5	100 m.	5704979340482
PX 020232	110 x 10,0	12,5	50 m.	5704979340499
PX 020234	110 x 10,0	12,5	100 m.	5704979340505



BEULCO SPÆNDEKOBLINGER

Trækfast spændkobling fremstillet i messing med KIWA prøvecertifikat.

Koblingen skal anvendes i kombination med en støttebøsning/messingindsats (skal bestilles separat!). Også egnet til gas.

Best. nr.	PE Str.	EAN/Barcode
Støttebøsning/messingindsats - separat		
Størrelserne markeret med * leveres fra lager.		
PQ 010300	*16 x 1,8	5704979441868
PQ 010304	*20 x 2,2	5704979441875
PQ 010308	25 x 2,3	5704979441882
PQ 010310	*25 x 2,7	5704979441899
PQ 010312	*32 x 2,0	5704979441905
PQ 010314	32 x 2,4	5704979441912
PQ 010316	32 x 3,0	5704979441929
PQ 010318	*32 x 3,5	5704979441936
PQ 010320	40 x 2,3	5704979441943
PQ 010322	*40 x 3,0	5704979441950
PQ 010324	*40 x 3,7	5704979441967
PQ 010326	*40 x 4,3	5704979441974
PQ 010330	*50 x 2,9	5704979441981
PQ 010332	*50 x 3,8	5704979441998
PQ 010334	*50 x 4,6	5704979442001
PQ 010336	*50 x 5,4	5704979442018
PQ 010338	63 x 3,0	5704979442025
PQ 010340	63 x 3,6	5704979442032
PQ 010342	*63 x 4,7	5704979442049
PQ 010346	*63 x 5,8	5704979442056
PQ 010348	*63 x 6,8	5704979442063
PQ 010350	75 x 3,6	5704979442070
PQ 010352	75 x 4,3	5704979442087
PQ 010354	*75 x 5,6	5704979442094
PQ 010356	75 x 6,9	5704979442100

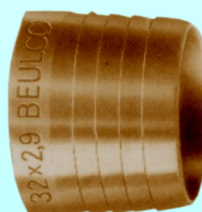
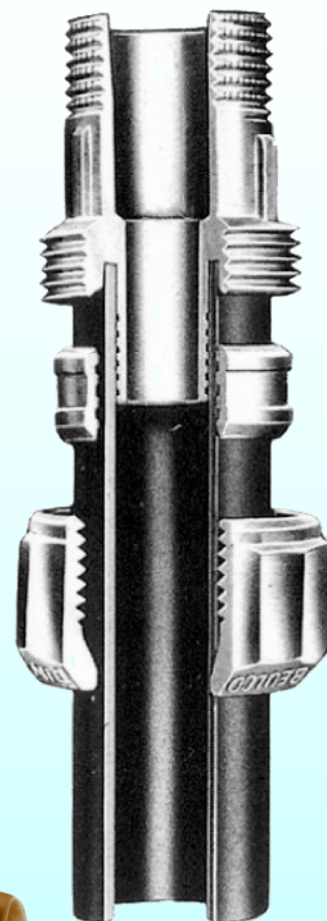

Best. nr.	Størrelse	EAN/Barcode
Messing kobling PE - med udvendigt gevind		
Støttebøsning/messingindsats skal bestilles separat.		
PQ 010380	16 x 3/8"	5704979442148
PQ 010382	20 x 1/2"	5704979442155
PQ 010384	25 x 3/4"	5704979442162
PQ 010386	32 x 1"	5704979442179
PQ 010388	40 x 1-1/4"	5704979442186
PQ 010390	50 x 1-1/2"	5704979442193
PQ 010392	63 x 2"	5704979442209
PQ 010394	75 x 2-1/2"	5704979442216



Best. Nr.	Størrelse	EAN/Barcode
Vægholder i messing x PE anker		
PQ 011110	16 x 1/2"	5704979442254

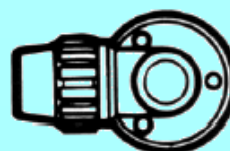

Best. nr.	Betegnelse	Mål	EAN/Barcode
PR 030125	Messingkobling indvendigt gevind	3/8"	5704979442292
PR 031100	Messingkobling indvendigt gevind	1/2"	5704979442308
PR 031101	Messingkobling indvendigt gevind	3/4"	5704979442315
PR 031102	Messingkobling indvendigt gevind	1"	5704979442322
PR 031103	Messingkobling indvendigt gevind	1 1/4"	5704979442339
PR 031104	Messingkobling indvendigt gevind	1 1/2"	5704979442346



Best. nr.	Betegnelse	Mål	EAN/Barcode
PR 040126	Messingkobling udvendigt gevind	3/8"	5704979442384
PR 041105	Messingkobling udvendigt gevind	1/2"	5704979442391
PR 041106	Messingkobling udvendigt gevind	3/4"	5704979442407
PR 041107	Messingkobling udvendigt gevind	1"	5704979442414
PR 041108	Messingkobling udvendigt gevind	1 1/4"	5704979442421
PR 041109	Messingkobling udvendigt gevind	1 1/2"	5704979442438



Best. nr.	Betegnelse	Mål	EAN/Barcode
PR 050127	Messing slangestuds	3/8"	5704979442476
PR 051110	Messing slangestuds	1/2"	5704979442483
PR 051111	Messing slangestuds	5/8"	5704979442490
PR 051112	Messing slangestuds	3/4"	5704979442506
PR 051113	Messing slangestuds	1"	5704979442513
PR 051114	Messing slangestuds	1 1/4"	5704979442520
PR 051115	Messing slangestuds	1 1/2"	5704979442537

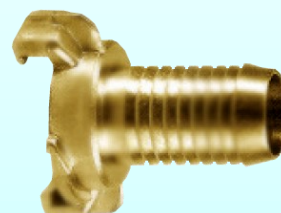

Best. nr.	Betegnelse	Mål	EAN/Barcode
PR 060130	Messing med drejbar slangestuds	1/2"	5704979442575
PR 060131	Messing med drejbar slangestuds	3/4"	5704979442582
PR 060132	Messing med drejbar slangestuds	1"	5704979442599

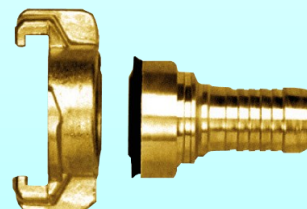

Best. nr.	Betegnelse	Mål	EAN/Barcode
PR 070116	Messing endekappe	Universal	5704979442629



Best. nr.	Betegnelse	Mål	EAN/Barcode
PR 070117	Gummiring / pakning	Universal	5704979442650



Best. nr.	Betegnelse	Mål	EAN/Barcode
PR 070118	Messing fordeler 1 x 3/4 female + 2 x 3/4 male		5704979442681



Best. nr.	Betegnelse	Mål	Studs	EAN/Barcode
PR 070120	Suge og højtrykskobling	1/2"	15 mm.	5704979442728
PR 070121	Suge og højtrykskobling	3/4"	20,5 mm.	5704979442735
PR 070122	Suge og højtrykskobling	1"	26 mm.	5704979442742
PR 070123	Suge og højtrykskobling	1 1/4"	32 mm.	5704979442759

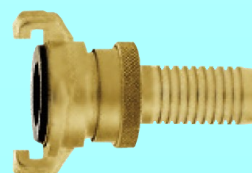

Kuglehane fremstillet i forkrommet messing med galvaniseret håndtag i stål. Eget til varmt og koldt vand, luft, olie, m.m..
Arbejdstemperatur: -20° C. til +150° C., Pakninger i teflon (PTFE).

Best. nr.	Str.	A	D	G	Maks. tryk	EAN/Barcode
Kuglehane - 2 x indvendigt gevind TYPE BASIC 213						
PR 010130	1/2"	15	9,28	59,5	45 bar v. 20°C	5704979442797
PR 010131	3/4"	20	10,4	69,7	40 bar v. 20°C	5704979442803
PR 010132	1"	25	11,7	79,5	35 bar v. 20°C	5704979442810
PR 010133	1-1/4"	32	17	97	30 bar v. 20°C	5704979442827
PR 010134	1-1/2"	40	20	110	25 bar v. 20°C	5704979442834
PR 010135	2"	50	20	125	20 bar v. 20°C	5704979442841

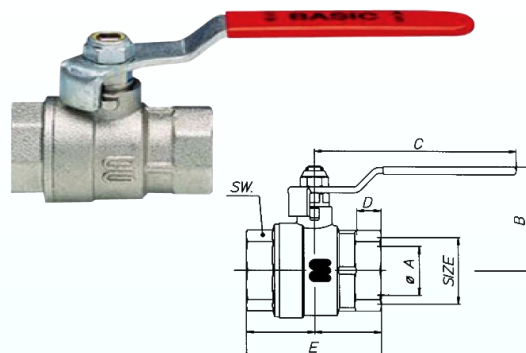

Stopventil med fuldt gennembløb og rødt håndhjul i stålblek. Eget til industri, landskabs- og havearkitektur.
Arbejdsttryk.: maks. 16 ATU ved 20° C., arbejdstemperatur: maks. 80° C.

Best. nr.	Str.	EAN/Barcode
Hane med messing-spjæld		
PR 010100	3/8"	5704979442889
PR 010101	1/2"	5704979442896
PR 010102	3/4"	5704979442902
PR 010103	1"	5704979442919
PR 010104	1-1/4"	5704979442926
PR 010105	1-1/2"	5704979442933
PR 010106	2"	5704979442940
PR 010107	2-1/2"	5704979442957
PR 010108	3"	5704979442964
PR 010109	4"	5704979442971
PR 010110	5"	5704979442988
PR 010111	6"	5704979442995



Fjederbelastet i messing, egnet til vand, luft, forskellige olieprodukter, m.m..
Monteres i alle positioner. Temp.: max. 110° C., pakning NBR, rustfri stål fjeder

Best. nr.	Str.	A	B	Bar	EAN/Barcode
Tilbageløbsventil type YORK					
PR 020101	3/8"	44	34	12	5704979443039
PR 020102	1/2"	46	34	12	5704979443046
PR 020103	3/4"	52	42	12	5704979443053
PR 020104	1"	56	48	12	5704979443060
PR 020105	1-1/4"	64	59	10	5704979443077
PR 020106	1-1/2"	73	70	10	5704979443084
PR 020107	2"	78	86	10	5704979443091
PR 020108	2-1/2"	94	102	8	5704979443107
PR 020109	3"	103	125	8	5704979443114
PR 020110	4"	116	153	8	5704979443121

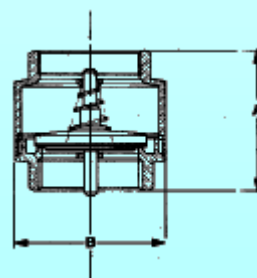

Forfilter med udv. Gevind Si: fremstillet i rustfri stål 304, gevind: nylon.

Best. nr.	Str.	A	B	Bar	EAN/Barcode
Forfilter med rustfri stål-si					
PR 030090	3/8"	70	34	10	5704979443169
PR 030091	1/2"	70	34	10	5704979443176
PR 030092	3/4"	82	42	10	5704979443183
PR 030093	1"	92	48	10	5704979443190
PR 030094	1-1/4"	107	59	8	5704979443206
PR 030095	1-1/2"	120	70	8	5704979443213
PR 030096	2"	136	86	8	5704979443220
PR 030097	2-1/2"	163	102	6	5704979443237
PR 030098	3"	184	125	6	5704979443244
PR 030099	4"	214	153	6	5704979443251



- Mekanisk gennemstrømningsmåler til horisontal montage, komplet med monterings-tilbehør.
- Rørlængde før gennemstrømningsmåleren: 10 x ledningsdiameter.
- Rørlængde efter gennemstrømningsmåleren: 5 x ledningsdiameter.
- Leveres op til 230 m³/time!

Best. nr.	Type	Til rør	EAN/Barcode
Flowmåler med propel			
PB 200442	4,5 - 18 m ³ /time	50 og 63 mm.	5704979444104
PB 200444	6,8 - 33 m ³ /time	50 og 63 mm.	5704979444111



- | | |
|---|--|
| <ul style="list-style-type: none"> - Kabinet: PVC. - Limforbindelse: PVC via 2/3 kobling. - Flyder: PVDF. - Pakning: EPDM. - Arbejdstryk : maks. 10 PN ved 20° C. - Arbejdstemperatur: maks. 60° C. | <ul style="list-style-type: none"> På bestilling leveres: - Pakning i Viton. - Målekabinet i polyamid. - Polysulfon. - P.V.D.F.. - Reedkontakter i komb. med flyderen. |
|---|--|

Best. nr.	D	Liter pr. time	Installationsmål	EAN/Barcode
Flowmåler med vægtlod				
PB 200450	32	60 - 600	350 mm.	5704979443985
PB 200452	32	100 - 1000	350 mm.	5704979443992
PB 200456	40	250 - 2500	350 mm.	5704979444005
PB 200460	50	200 - 2000	350 mm.	5704979444012
PB 200462	50	300 - 3000	350 mm.	5704979444029
PB 200470	63	600 - 6000	350 mm.	5704979444036
PB 200472	63	1000 - 10000	350 mm.	5704979444043
PB 200480	75	2500 - 25000	350 mm.	5704979444050
PB 200482	75	10000 - 50000	350 mm.	5704979444067



- | | |
|---|--|
| <ul style="list-style-type: none"> - Kabinet: PVC. - Limforbindelse: PVC via 2/3 kobling. - Flyder: PVDF. - Pakning: EPDM. - Arbejdstryk : maks. 10 PN ved 20° C. - Arbejdstemperatur: maks. 60° C. | <ul style="list-style-type: none"> På bestilling leveres: - Pakning i Viton. - Målekabinet i polyamid. - Polysulfon. - P.V.D.F.. - Reedkontakter i komb. med flyderen. |
|---|--|

Best. nr.	D	Liter pr. time	Installationsmål	EAN/Barcode
Flowmåler med vægtlod				
PB 200489	63	1600 - 16000	340 mm.	5704979444074
PB 200490	75	5000 - 25000	430 mm.	5704979444081

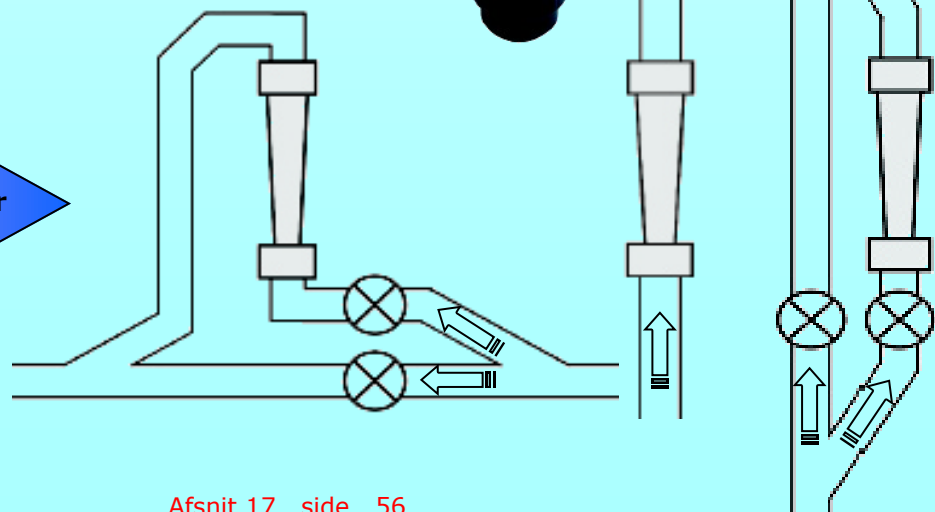

Stålkabinet 63 mm. Tør - 1/4" tilslutning fornedet

Best. nr.	Område (bar)	EAN/Barcode
Manometer		
CT 000100	- 1 + 0	5704979444142
CT 000101	- 1 + 3	5704979444159
CT 000102	0 - 0,6	5704979444166
CT 000103	0 - 1	5704979444173
CT 000104	0 - 1,6	5704979444180
CT 000105	0 - 2,5	5704979444197
CT 000106	0 - 4	5704979444203
CT 000107	0 - 6	5704979444210
CT 000108	0 - 10	5704979444227
CT 000109	0 - 16	5704979444234
CT 000110	0 - 25	5704979444241
CT 000111	0 - 40	5704979444258
CT 000112	0 - 60	5704979444265

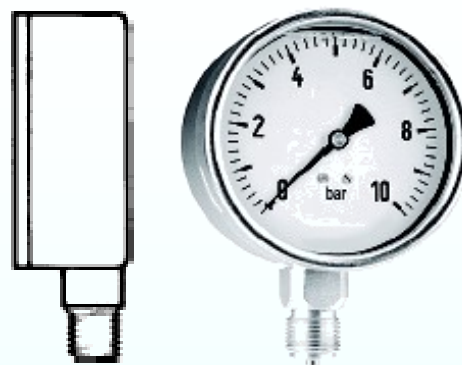

Stålkabinet 63 mm. Tør - 1/4" tilslutning bagerst

Best. nr.	Område (bar)	EAN/Barcode
Manometer		
CT 000160	- 1 + 0	5704979444302
CT 000161	- 1 + 3	5704979444319
CT 000162	0 - 0,6	5704979444326
CT 000163	0 - 1	5704979444333
CT 000164	0 - 1,6	5704979444340
CT 000165	0 - 2,5	5704979444357
CT 000166	0 - 4	5704979444364
CT 000167	0 - 6	5704979444371
CT 000168	0 - 10	5704979444388
CT 000169	0 - 16	5704979444395
CT 000170	0 - 25	5704979444401
CT 000171	0 - 40	5704979444418
CT 000172	0 - 60	5704979444425

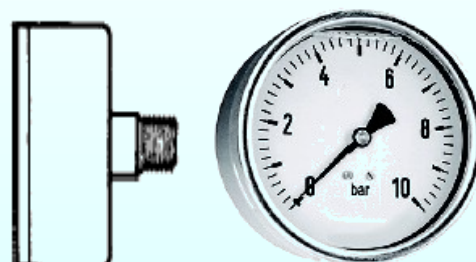

- KIWA certifikat - Vådløber. - Arbejdstryk: maks. 16 bar. -

Best. nr.	Type QN	Q min.	Q max.	Gennemg.	Udv. Gev.	EAN/Barcode
Vandmåler TYPE DS78TBR						
CT 001000	1,5	30 l/t	3.000 l/t	1/2"	3/4"	5704979444463
CT 001020	2,5	50 l/t	5.000 l/t	3/4"	1"	5704979444470
CT 001040	3,5	70 l/t	7.000 l/t	1"	1-1/4"	5704979444487
CT 001060	5	100 l/t	10.000 l/t	1-1/4"	1-1/2"	5704979444494
CT 001080	10	200 l/t	20.000 l/t	1-1/2"	2"	5704979444500
CT 001100	15	450 l/t	30.000 l/t	2"	*Flange	5704979444517



- Koldvandsmåler. - Tørsløber. - Arbejdstryk: maks. 16 bar. - Indikerer/viser også liter!

Best. nr.	Type QN	Q min	Q maks.	Gennemg.	Udv. Gev.	EAN/Barcode
Vandmåler TYPE CD SUPER DRY						
CT 001280	1,5	30 l/t	3.000 l/t	1/2"	3/4"	5704979444623
CT 001300	2,5	50 l/t	5.000 l/t	3/4"	1"	5704979444630



Best. nr.	Udv. Gev.	Øskænbolt tilslutning indv. Gev.	EAN/Barcode
Kobling til vandmåler			
CT 001600	1/2"	3/4"	5704979444678
CT 001620	3/4"	1"	5704979444685
CT 001640	1"	1-1/4"	5704979444692
CT 001660	1-1/4"	1-1/2"	5704979444708
CT 001680	1-1/2"	2"	5704979444715
CT 001700	2"	2-1/2"	5704979444722

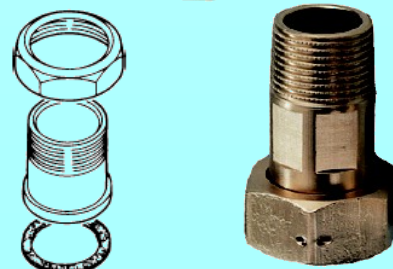



Pos.	Best. nr.	Glasfiber Repair Kit	Størrelse	EAN/Barcode
A	IP 010050	Reparation sæt til glasfiber	Sæt komplet	5704979740022

Pos.	Best. nr.	Pensler	Størrelse	EAN/Barcode
B	IO 004200	Pensel nr. 10 Ø.16 mm.	12- 32 mm.	5704979740053
B	IO 004210	Pensel nr. 12 Ø.19 mm.	20- 32 mm.	5704979740060
B	IO 004220	Pensel nr. 14 Ø.22 mm.	25- 40 mm.	5704979740077
B	IO 004230	Pensel nr. 18 Ø.28 mm.	32- 50 mm.	5704979740084
B	IO 004240	Pensel nr. 20 flad 30 mm.	40- 63 mm.	5704979740091
B	IO 004250	Pensel nr. 22 flad 50 mm.	75-200 mm.	5704979740107

Pos.	Best. nr.	Glidemiddel	Størrelse	EAN/Barcode
	IN 001340	P-20 Glidemiddel i tube	500 gr.	5704979320347
C	IN 001350	P-20 Glidemiddel i bøtte	800 gr.	5704979320354

Pos.	Best. nr.	Pakke og tætningsprodukter	Til rør	EAN/Barcode
D	IO 010119	Teflon pakketape super GUL	12 m.	5704979320422
E	IO 010120	Teflon pakketape RØD	12 m.	5704979320439
F	IO 010146	Tangit Uni-Lock pakkesnor	80 m.	5704979320446
G	IO 010160	Loctite 5331 gevind pakning PVC	100 ml.	5704979320453
H	IO 010170	Loctite 577 gevind pakning metal	50 ml.	5704979320460
I	IO 010180	Wrap & Seal universal pakketape	2,4 m.	5704979320477
I	IO 010182	Wrap & Seal universal pakketape	4,8 m.	5704979320484

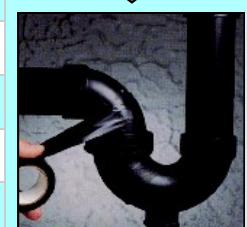
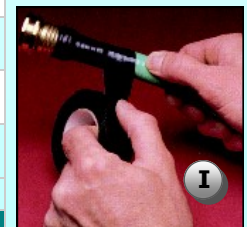
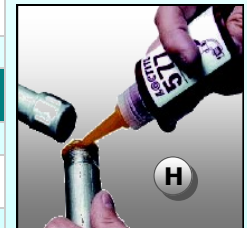

Lim til alle formål

Skulle der alligevel være produkter du ikke finder - så spørg, og vi skaffer det !



A

Pos.	Best. nr.	PVC folielim	Størrelse	EAN/Barcode
A	IN 000125	PVC folie lim	125 ml.	5704979740213
A	IN 000250	PVC folie lim	250 ml.	5704979740220
A	IN 001000	PVC folie lim	1000 ml.	5704979740237



C

B

Pos.	Best. nr.	EPDM tætning og lim	Størrelse	EAN/Barcode
B	IN 001010	Butyl tape dobbeltklæbende	10 m.	5704979740329
C	IN 001020	EPDM rep. og svejsetape	10 cm x pr. m.	5704979740336
D	IN 001040	EPDM lim pasta	1 ltr.	5704979740343

E

E	IN 001060	Nautic Multi rep. "lapper alt"	2 x pr. pose	5704979740374
---	-----------	--------------------------------	--------------	---------------



F

G

Pos.	Best. nr.	Lim-produkter	Størrelse	EAN/Barcode
F	IN 002260	Fix&Seal Sort	290 ml.	5704979740480
F	IN 002261	Fix&Seal Hvid	290 ml.	5704979740497
F	IN 002262	Fix&Seal Transparent	290 ml.	5704979740503
G	IN 002010	Glassilicone transparent	310 ml.	5704979740510



Pos.	Best. nr.	Weld On - Limer u. vand	Størrelse	EAN/Barcode
------	-----------	-------------------------	-----------	-------------

H	IN 005010	Weld On PVC lim + pensel	240 ml.	5704979320033
H	IN 005025	Weld On PVC lim + pensel	500 ml.	5704979320040



H

Pos.	Best. nr.	Tangit. PVC lim	Størrelse	EAN/Barcode
------	-----------	-----------------	-----------	-------------

I	IN 003010	PVC lim i tube	125 ml.	5704979320156
I	IN 003020	PVC lim i dåse med pensel	250 ml.	5704979320163
I	IN 003030	PVC lim i dåse med pensel	500 ml.	5704979320170
I	IN 003040	PVC lim i dåse med pensel	1000 ml.	5704979320187
I	IN 003050	PVC lim i dåse	1000 ml.	5704979320194



I

Pos.	Best. nr.	Rensemiddel	Størrelse	EAN/Barcode
------	-----------	-------------	-----------	-------------

J	IN 004114	Griffon Rensevæske	125 ml.	5704979320255
J	IN 004115	Griffon Rensevæske	500 ml.	5704979320262
J	IN 004020	Tangit Rensevæske	1000 ml.	5704979320279



J



A

Rør og omløberstrammer fra 25 til 110 mm.

Afgrater som let afgrater rør fra 16 til 63 mm.



B



C



D

Rulle rørskeer til PVC og PP rør fra 10 til 160 mm. Se tabellen



E



F

Praktisk afkotersaks som let klarer PE rør og slanger fra 16 til 32 mm.



G

Praktisk oppustelig gummibold i 5 størrelser som let stopper vandet, så en forandring eller en reparation kan udføres helt uden besvær.

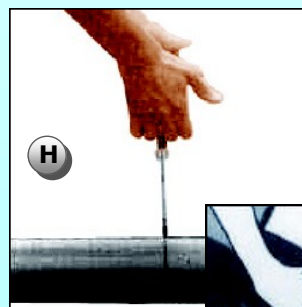

H

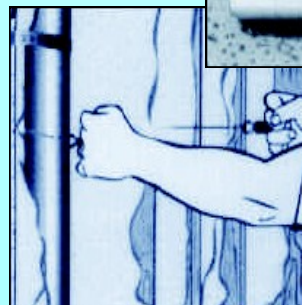
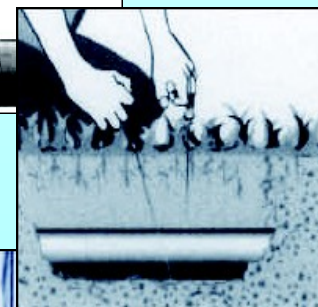

Med denne sav tråd kan afkorting udføres- selv på steder hvor det ellers ville være umuligt.



Professionel lim pistol med olietryk og udløserstop.

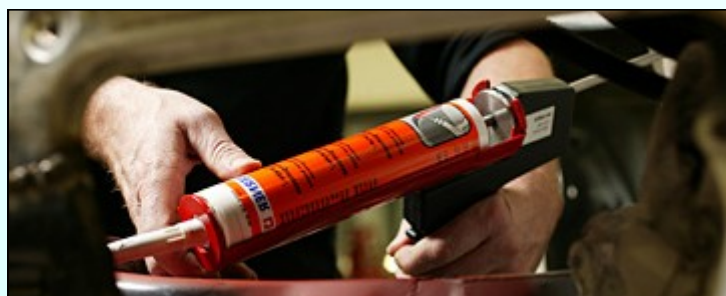

Professionel lim pistol til trykluft.

Pos.	Best. nr.	Glasfiber Repair Kit	Størrelse	EAN/Barcode
A.	PZ 010475	Rør & omløber strammer	25 - 110 mm.	5704979320552
B.	PZ 010470	PVC & PE afgrater	16 - 63 mm.	5704979320569
C.	PZ 010484	Rulle rørskære 10- 63 mm.	10 - 63 mm.	5704979320576
	PZ 010486	Skærehjul 10- 63 mm.		5704979320583
D.	PZ 010488	Rulle rørskære 50- 110 mm.	50 - 110 mm.	5704979320590
	PZ 010490	Skærehjul 50- 110 mm		5704979320606
E.	PZ 010492	Rulle rørskærer 110- 160 mm.	110 - 160 mm.	5704979320613
	PZ 010494	Skærehjul 110-160 mm		5704979320620
F.	PZ 010477	Saks / klipper til PE rør og slanger	16 - 32 mm.	5704979320637
G.	PZ 010600	Flowstop oppustelig gummibold	45 - 75 mm.	5704979444760
G.	PZ 010602	Flowstop oppustelig gummibold	72 - 92 mm.	5704979444777
G.	PZ 010604	Flowstop oppustelig gummibold	92 - 145 mm.	5704979444784
G.	PZ 010605	Flowstop med 3 m. slange & ventil	92 - 145 mm.	5704979444791
G.	PZ 010606	Flowstop oppustelig gummibold	145 - 200 mm.	5704979444807
G.	PZ 010608	Flowstop oppustelig gummibold	200 - 320 mm.	5704979444814
	PZ 010610	Håndpumpe		5704979444821
H.	PZ 010478	Båndskærer i Rustfri Stål med 2 håndtag	100 cm.	5704979320644
I.	IN 001515	Standard silikonepistol i metal	Til 290 - 310 ml.	5704979740602
J.	IN 001505	Silikonepistol Prof. model med slip	Til 290 - 310 ml.	5704979740619
K.	IN 001510	Silikonepistol Prof. model til trykluft	Til 290 - 310 ml.	5704979740626

Best. nr.	Mål B	Stop	EAN/Barcode
Slangestuds			
PR 080220	38 mm.	52	5704979443299
PR 080221	38 mm.	66	5704979443305
PR 080222	50 mm.	66	5704979443312
PR 080223	50 mm.	81	5704979443329
PR 080224	63 mm.	81	5704979443336
PR 080225	75 mm.	81	5704979443343
PR 080229	63 mm.	89	5704979443350
PR 081226	75 mm.	89	5704979443367
PR 081227	100 mm.	115	5704979443374
PR 081228	100 mm.	133	5704979443374

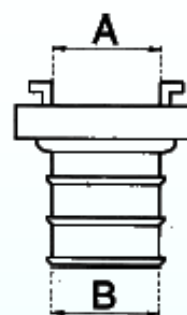

Best. nr.	Mål	Stop	EAN/Barcode
Indergevind			
PR 090239	1½ "	66	5704979443411
PR 090240	2"	66	5704979443428
PR 090241	2"	81	5704979443435
PR 090242	2½ "	81	5704979443442
PR 090246	3"	81	5704979443459
PR 090247	2"	89	5704979443466
PR 090248	2½ "	89	5704979443473
PR 091243	3"	89	5704979443480
PR 091244	4"	115	5704979443497
PR 091245	4"	133	5704979443503



Best. nr.	Mål	Stop	EAN/Barcode
Ydergevind			
PR 100250	1½ "	66	5704979443541
PR 100251	2"	66	5704979443558
PR 100252	2"	81	5704979443565
PR 100253	2½ "	81	5704979443572
PR 100258	3"	81	5704979443589
PR 101257	2½ "	89	5704979443596
PR 101254	3 "	89	5704979443602
PR 101255	4"	115	5704979443619
PR 101256	4"	133	5704979443626



Best. nr.	Mål	EAN/Barcode
Reducering		
PR 110260	66 x 81	5704979443640
PR 110261	66 x 89	5704979443657
PR 110264	81 x 89	5704979443664
PR 111262	88 x 115	5704979443671
PR 111263	89 x 133	5704979443688



Best. nr.	Stop	EAN/Barcode
Endekappe med kæde		
PR 120270	66	5704979443725
PR 120271	81	5704979443732
PR 120272	89	5704979443749
PR 120273	115	5704979443756
PR 120274	133	5704979443763



Best. nr.	Mål	EAN/Barcode
Gummipakning sug/tryk		
PR 130280	52	5704979443800
PR 130281	66	5704979443817
PR 130282	81	5704979443824
PR 130283	89	5704979443831
PR 130284	115	5704979443848
PR 130285	133	5704979443855



Best. nr.		EAN/Barcode
PR 130286	Nøgle	5704979443893

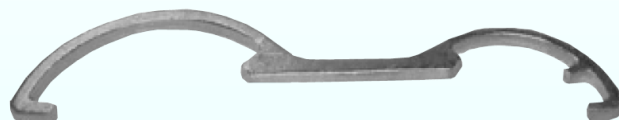

Best. nr.	MÅL	EAN/Barcode
Multigrib-hane		
PR 130287	66	5704979443930
PR 130288	81	5704979443947



Best. Nr.	Rør størrelse	Gevind	EAN/Barcode
Anboringbøjle PP - u. forstærkning			
PV 010206	32 mm.	1/2"	5704979418846
PV 010208	32 mm.	3/4"	5704979418853
PV 010210	40 mm.	1/2"	5704979418860
PV 010212	40 mm.	3/4"	5704979418877
PV 010214	40 mm.	1"	5704979418884
PV 010218	50 mm.	3/4"	5704979418891
PV 010220	50 mm.	1"	5704979418907
PV 010224	63 mm.	3/4"	5704979418914
PV 010226	63 mm.	1"	5704979418921
PV 010236	75 mm.	1"	5704979418938
PV 010242	75 mm.	2"	5704979418945
PV 010252	90 mm.	2"	5704979418952

Boringsadel fremstillet i polypropylen. Udstyret med gevindbolt og møtrikker.

Arbejdstryk op til 90 mm.: 10 bar.

Sadler op til 50 mm. har 2 gevindbolte,
Sadler fra 63 - 90 mm. har 4 gevindbolte.



Best. nr.	Rør størrelse	Gevind	EAN/Barcode
Anboringsbøjle PP - med forstærkning af rustfrit stål			
PV 010100	20 mm.	1/2"	5704979418228
PV 010101	25 mm.	1/2"	5704979418235
PV 010102	25 mm.	3/4"	5704979418242
PV 010103	32 mm.	1/2"	5704979418259
PV 010104	32 mm.	3/4"	5704979418266
PV 010105	32 mm.	1"	5704979418273
PV 010106	40 mm.	1/2"	5704979418280
PV 010107	40 mm.	3/4"	5704979418297
PV 010108	40 mm.	1"	5704979418303
PV 010109	50 mm.	1/2"	5704979418310
PV 010110	50 mm.	3/4"	5704979418327
PV 010111	50 mm.	1"	5704979418334
PV 010113	63 mm.	1/2"	5704979418341
PV 010114	63 mm.	3/4"	5704979418358
PV 010115	63 mm.	1"	5704979418365
PV 010116	63 mm.	1-1/4"	5704979418372
PV 010117	63 mm.	1-1/2"	5704979418389
PV 010118	75 mm.	1/2"	5704979418396
PV 010119	75 mm.	3/4"	5704979418402
PV 010120	75 mm.	1"	5704979418419
PV 010121	75 mm.	1-1/4"	5704979418426
PV 010122	75 mm.	1-1/2"	5704979418433
PV 010123	75 mm.	2"	5704979418440
PV 010124	90 mm.	1/2"	5704979418457
PV 010125	90 mm.	3/4"	5704979418464
PV 010126	90 mm.	1"	5704979418471
PV 010127	90 mm.	1-1/4"	5704979418488
PV 010128	90 mm.	1-1/2"	5704979418495
PV 010129	90 mm.	2"	5704979418501
PV 010130	110 mm.	1/2"	5704979418518
PV 010131	110 mm.	3/4"	5704979418525
PV 010132	110 mm.	1"	5704979418532
PV 010133	110 mm.	1-1/4"	5704979418549
PV 010134	110 mm.	1-1/2"	5704979418556
PV 010135	110 mm.	2"	5704979418563
PV 010137	125 mm.	3/4"	5704979418570
PV 010138	125 mm.	1"	5704979418587
PV 010139	125 mm.	1-1/4"	5704979418594
PV 010140	125 mm.	1-1/2"	5704979418600
PV 010141	125 mm.	2"	5704979418617
PV 010146	140 mm.	1"	5704979418624
PV 010147	140 mm.	1-1/4"	5704979418631
PV 010148	140 mm.	1-1/2"	5704979418648
PV 010149	140 mm.	2"	5704979418655
PV 010150	140 mm.	3"	5704979418662
PV 010154	160 mm.	1"	5704979418679
PV 010155	160 mm.	1-1/4"	5704979418686
PV 010156	160 mm.	1-1/2"	5704979418693
PV 010157	160 mm.	2"	5704979418709
PV 010158	160 mm.	3"	5704979418716
PV 010159	160 mm.	4"	5704979418723
PV 010160	200 mm.	2"	5704979418730
PV 010161	200 mm.	3"	5704979418747
PV 010162	200 mm.	4"	5704979418754
PV 010163	250 mm.	2"	5704979418761
PV 010164	250 mm.	3"	5704979418778
PV 010165	250 mm.	4"	5704979418785

Boringsadel fremstillet i polypropylen.

Udstyret med gevindbolt og møtrikker samt forstærkningsring i rustfrit stål.

Arbejdstryk op til 160 mm.: 10 bar.

Arbejdstryk 200 til 315 mm.: 6 bar.

Sadler op til 50 mm. har 2 gevindbolte,

Sadler fra 63- 152 mm. har 4 gevindbolte.

Sadler fra 140- 315 mm. har 6 gevindbolte.

